

NBS, NBSE



Service instructions



NBS, NBSE

English (GB)

Service instructions	4
----------------------------	---

Original service instructions

Table of contents

1. General information	4
1.1 Hazard statements	4
1.2 Notes	4
1.3 Target group	4
2. Identification	5
2.1 Nameplate	5
2.2 Type key	6
3. Service tools	10
4. Disassembly and assembly	11
4.1 Disassembling the pump	11
4.2 Checking gap between impeller and pump housing/ cover (wear rings)	14
4.3 Removing the impeller	14
4.4 Assembling the pump	15
5. High pressure seal replacement	22
5.1 Dismantling old seal	22
5.2 Assembling new seal	23
6. Reference information	26
6.1 Torque table	26
6.2 Recommended lubricants	26
6.3 Gap between impeller and pump housing/cover (wear rings)	27
6.4 Related documents	28
6.5 Service videos	28
7. Fault finding	29
8. Exploded drawings	31

1. General information



Read this document before you start service work on the product. Service work must comply with local regulations and accepted codes of good practice.

Observe the safety instructions in the installation and operating instructions for the product.

1.1 Hazard statements

The symbols and hazard statements below may appear in Grundfos installation and operating instructions, safety instructions and service instructions.

**DANGER**

Indicates a hazardous situation which, if not avoided, will result in death or serious personal injury.

**WARNING**

Indicates a hazardous situation which, if not avoided, could result in death or serious personal injury.

**CAUTION**

Indicates a hazardous situation which, if not avoided, could result in minor or moderate personal injury.

The hazard statements are structured in the following way:

SIGNAL WORD**Description of the hazard**

Consequence of ignoring the warning

- Action to avoid the hazard.



1.2 Notes

The symbols and notes below may appear in Grundfos installation and operating instructions, safety instructions and service instructions.



Observe these instructions for explosion-proof products.



A blue or grey circle with a white graphical symbol indicates that an action must be taken.



A red or grey circle with a diagonal bar, possibly with a black graphical symbol, indicates that an action must not be taken or must be stopped.



If these instructions are not observed, it may result in malfunction or damage to the equipment.



Tips and advice that make the work easier.

1.3 Target group

These service instructions are intended for professional installers, operators and service technicians of the product.

We recommend that service and maintenance be carried out by skilled persons with technical qualifications required by the specific legislation in force.

2. Identification

2.1 Nameplate

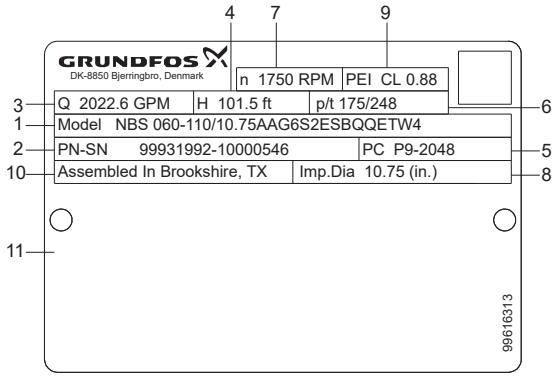

TM075296

Example of NBS nameplate

Pos.	Description
1	Type designation
2	Product number and production serial number
3	Flow
4	Head
5	Production code
6	Pressure and temperature
7	Pump speed
8	Impeller diameter
9	PEI CL: Pump Energy Index, constant load PEI VL: Pump Energy Index, variable load
10	Place of production
11	Field for approval marks and associated texts

2.1.1 Looking up service parts in Grundfos Product Center

- Always check the production code (PC code) on the nameplate before looking up service parts in Grundfos Product Center.
- Different codes are created if the modified service parts are not backwards interchangeable.

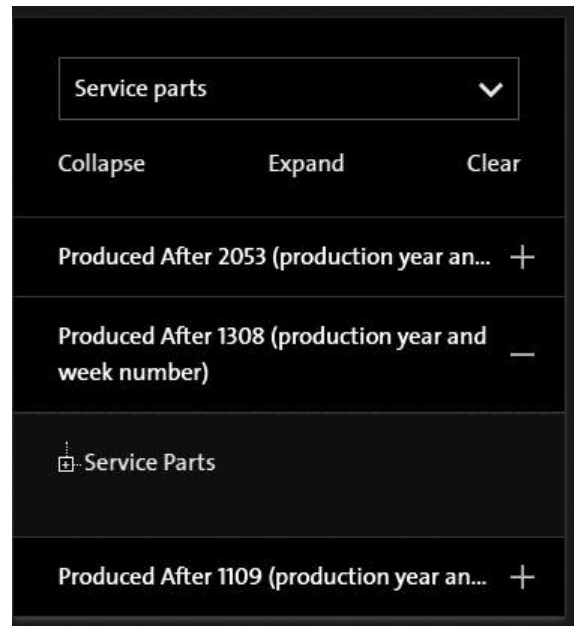

TM080702

2.2 Type key

Example 1: NBS 025-095/08.43AAEG6S3ESBQQETX2
Example 2: NBS 040-150/16.77AFEG7TBESDQQE1X4**Example 3: NBS 060-135/1291-1276AAEG7TBESDQQEWX4****Example 4: NBSE 025-110/11.02ASFEG6S2ESBQQENDA****Example 5: NBSE 030-110/1094-1063ACAEG7S7FSDAQFODA**

Pos.	1	2	3	4	5	6	7	8	9	10	11	12	13	14	15	16	17
Example 1	NBS	025	-095	/8.43		A		AE	G	6	S3	E	S	BQQE	T	X	2
Example 2	NBS	040	-150	/16.77		A		FE	G	7	TB	E	S	DQQE	1	X	4
Example 3	NBS	060	-135	/1291-1276		A		AE	G	7	TB	E	S	DQQE	W	X	4
Example 4	NBSE	025	-110	/11.02		A	S	FE	G	6	S2	E	S	BQQE	N	D	A
Example 5	NBSE	030	-110	/1094-1063		A	C	AE	G	7	S7	F	S	DAQF	O	D	A

Pos.	Explanation
1	Type range
2	Nominal diameter of outlet port (DN)
3	Nominal impeller diameter [inch]
4	Actual impeller diameter [inch]
	Impeller type
5	'blank': Closed impeller, cylindrical trim. If one dimension is shown the impeller has a cylindrical trim, for example 11.02 'blank': Closed impeller, conical trim. If two dimensions are shown the impeller has a conical trim, for example 1094-1063 S: Semi-open impeller V: Super vortex impeller
	Hydraulic version
6	A: 1st version B: 2nd version C: 3rd version D: 4th version
	Sensor version
7	'blank': Pump without sensor C: Without built-in sensor, one cable and one pressure sensor are supplied with the pump S: Pump with built-in differential-pressure sensor, Series 2000
	Code for pump version; the codes may be combined
8	A: Basic version B: Oversize motor C: Without motor (+E): With ATEX approval, certificate or test report, the second character of the code for pump version is an E F: Design with base frame (+S): With support rails, the second character of the pump version code is an S X: Special version; used in case of further customisationcustomization than already listed
	Pipe connection
9	G: ANSI flange
	Flange pressure rating (PN - rated pressure)
10	5: Other pressure rating 6: Class 125, 175 PSI 7: Class 300, 363 PSI

Pos.	Explanation				
	Code for materials				
	Code	Pump housing	Impeller	Wear ring	Shaft
	S2	A48 Class 35	304	No wear ring	420
	S3	A48 Class 35	304	No wear ring	304
	S4	A48 Class 35	304	No wear ring	316
	S5	A48 Class 35	304	No wear ring	SAF 2205
	S6	A48 Class 35	316	No wear ring	420
	S7	A48 Class 35	316	No wear ring	304
	S8	A48 Class 35	316	No wear ring	316
	S9	A48 Class 35	316	No wear ring	SAF 2205
11	SA	70-50-05	304	No wear ring	420
	SB	70-50-05	304	No wear ring	304
	SC	70-50-05	304	No wear ring	316
	SD	70-50-05	304	No wear ring	SAF 2205
	SE	70-50-05	316	No wear ring	420
	SF	70-50-05	316	No wear ring	304
	SG	70-50-05	316	No wear ring	316
	SH	70-50-05	316	No wear ring	SAF 2205
	T2	A48 Class 35	CD4MCuN/A890	No wear ring	SAF 2205
	TA	70-50-05	CD4MCuN/A890	No wear ring	SAF 2205
	X	Special version			
	Rubber parts in pump				
	E: EPDM				
	F: FXM (Fluoraz®)				
12	K: FFKM (Kalrez®)				
	M: FEPS (PTFE-sheathed silicone O-ring)				
	O: HNBR				
	V: FKM (Viton®)				
	Shaft seal arrangement				
13	S: Single seal				
	Shaft seal in pump				
14	Letter code for mechanical shaft seal and shaft seal rubber parts. See section Letter codes for shaft seals.				
15	Code for rated motor power [kW]. See section Codes for rated motor power.				
16	Code for phase and voltage [V] or other information. See section Codes for phase and voltage or other information.				
17	Code for speed variant [rpm]. See section Codes for speed variant.				

2.2.1 Letter codes for shaft seals

Pos. 14 in NBS type key example.

Code example	Description	Code explanation
B	Shaft seal type	A: O-ring seal with fixed driver B: Rubber bellows seal D: O-ring seal, balanced H: Cartridge seal, balanced
Q	Material of rotating seal face	A: Carbon, metal-impregnated with antimony which is not approved for potable water B: Carbon, resin-impregnated Q: Silicon carbide
Q	Material of stationary seal	A: Carbon, metal-impregnated with antimony which is not approved for potable water Q: Silicon carbide
E	Material of secondary seal and other rubber and composite parts, except the wear ring	E: EPDM V: FKM (Viton®) F: FXM (Fluoraz®) K: FFKM (Kalrez®) X: HNBR U: Dynamic O-rings in FFKM and static O-rings in PTFE

2.2.2 Codes for rated motor power

Pos. 15 in NBSE, NBS type key example.

Code	Description	
	[hp]	[kW]
A	0.16	0.12
B	0.25	0.18
C	0.33	0.25
D	0.5	0.37
E	0.75	0.55
F	1	0.75
G	1.5	1.1
H	2	1.5
I	3	2.2
J	4	3
K	5 (5.5 ¹)	3.7 (4 ¹)
L	7.5	5.5
M	10	7.5
N	15	11
O	20	15
P	25	18.5
Q	30	22
R	40	30
S	50	37
T	60	45
U	75	55
V	100	75
W	125	90
X	Bare pump	
Y	> 200 ²	> 150 ²
1	150	110
2	175	132
3	200	150
4	215 ³	160
5	250 ³	185

¹ Value in bracket is for the standard IEC motor size. Value outside bracket is for the motor size according to NEMA standards.

² Used for pumps where the pump shaft input power exceeds 200 hp (150 kW) and is not regulated under the DOE pump rule.

³ Special cases with power sizes above 200 hp (150 kW) which are still regulated under the DOE pump rule. For example: Pump has a P2 value of 198 hp (147.6 kW) in its duty point (in DOE scope) but customer wants the 215 hp (160 kW) motor instead of the 200 hp (150 kW). The pump is in scope of the DOE regulation and requires a PEI value and a motor code.

2.2.3 Codes for phase and voltage or other information

Pos. 16 in NBSE, NBS type key example.

Code	Description
A	E-motor (ECM ¹), 1 x 200-240 V
B	E-motor (ECM ¹), 3 x 200-240 V
C	E-motor (ECM ¹), 3 x 440-480 V
D	E-motor (ECM ¹), 3 x 380-500 V
V	Intended for use with external VFD only, asynchronous motor
W	Not for sale in North America
X	No motor or US DOE regulated motor (CC marked motor)
Y	Out of DOE scope
Z	E-motor, asynchronous motor

¹ ECM: Electronically Commutated Motor.

2.2.4 Codes for speed variant

Pos. 17 in NBSE, NBS type key example.

Code	Description
A	1450-2200 RPM, E-motor (ECM ¹)
B	2900-4000 RPM, E-motor (ECM ¹)
C	4000-5900 RPM, E-motor (ECM ¹)
1	2-pole, 50 Hz (Asynchronous motor)
2	2-pole, 60 Hz (Asynchronous motor)
3	4-pole, 50 Hz (Asynchronous motor)
4	4-pole, 60 Hz (Asynchronous motor)
5	6-pole, 50 Hz (Asynchronous motor)
6	6-pole, 60 Hz (Asynchronous motor)
7	8-pole, 50 Hz (Asynchronous motor)
8	8-pole, 60 Hz (Asynchronous motor)

¹ ECM: Electronically Commutated Motor.

3. Service tools

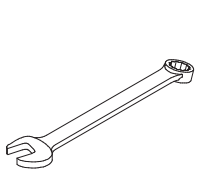

Ring/open-end spanner

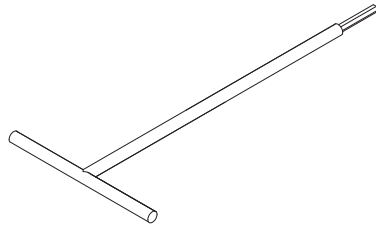

Hexagon T-key

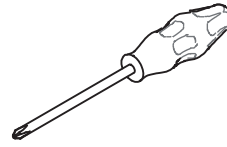

Cross-recess screwdriver

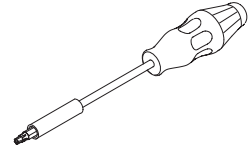

Reversible-bit screwdriver

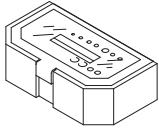

Bits kit

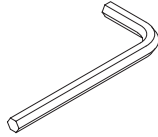

Hexagon key

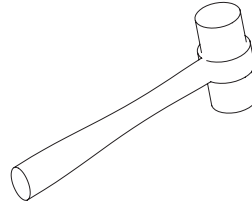

Plastic hammer

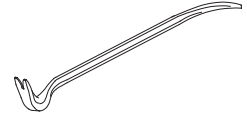

Pry bar

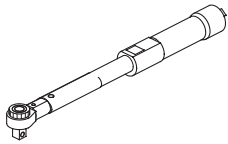

Torque wrench

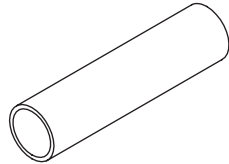

Punch for shaft seal



Gauge for inner diameter measurement of wear ring

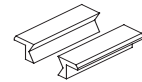

Soft jaws

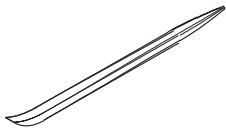

Pinch bar

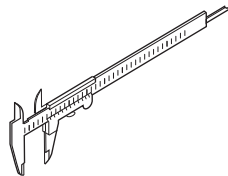

Sliding gauge

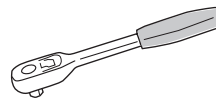

Ratchet spanner with socket

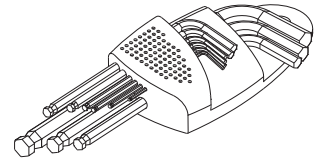

Hexagon key set

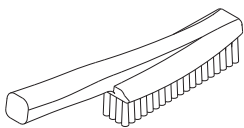

Steel brush



Safety shoes



Safety helmet

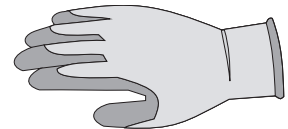

Safety gloves

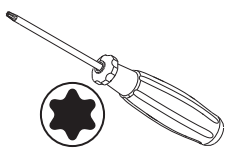

Screwdriver, Torx

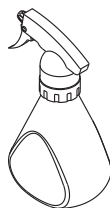

Sprayer

4. Disassembly and assembly

WARNING
Overhead load



Death or serious personal injury

- Pay attention to the pump weight, and take precautions to prevent personal injury if the pump topples or falls by accident.

CAUTION
Crushing of feet



Minor or moderate personal injury

- Do not drop pump components when servicing the product.

Check also the following service videos in association with this task:

How to dismantle and assemble Grundfos NBS single-stage pump



How to replace low pressure shaft seal on Grundfos NBS single-stage pump



4.1 Disassembling the pump

1. Remove coupling guard.



TM080356

2. Remove fork tool to access the split coupling.



TM080357

3. Loosen coupling screws.



TM080358

4. Remove split coupling pieces.

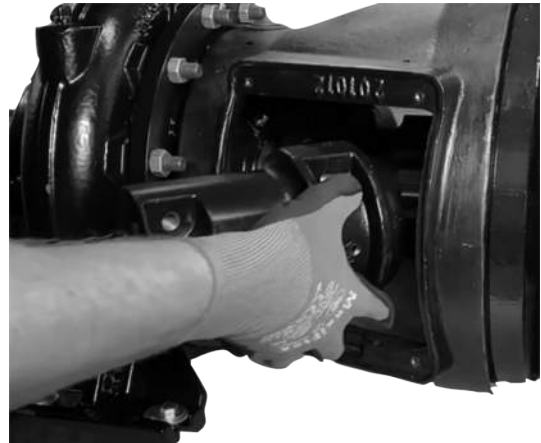

TM080359

5. Loosen set screws which fixate motor and pump keys.

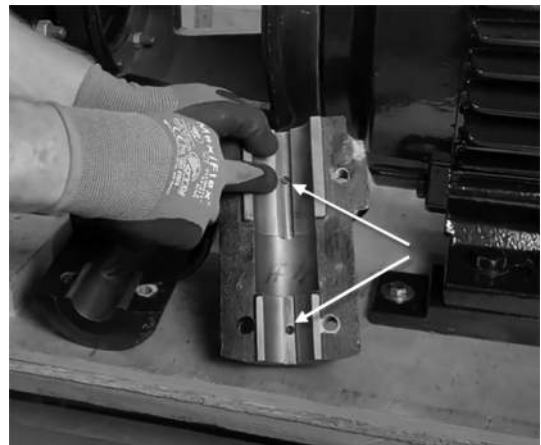

TM080360



TM080361

6. Remove pump and motor keys.



TM080362

10. Remove stationary part of the shaft seal from seal cover.



TM080367

7. Loosen seal cover screws.

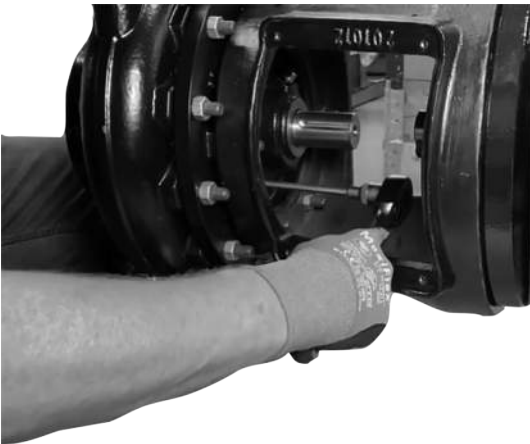

TM080363

11. Note O-ring condition on shaft seal and on seal cover (surface cracks, stiffness, swelling).



8. Remove seal cover.



TM080364

12. Remove rotating part of the shaft seal.

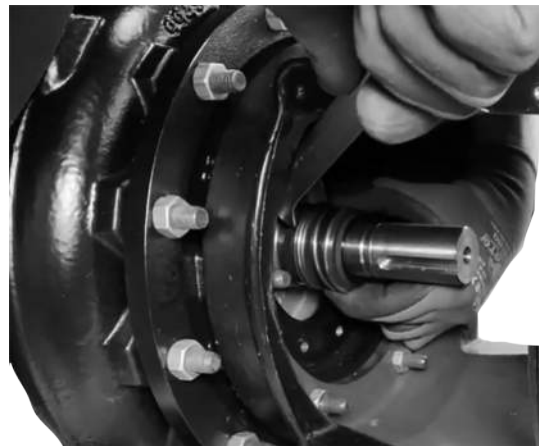

TM080369

9. If seal cover is stuck to the pump housing cover use two seal cover screws as jacking bolts.



TM080370

13. Check condition of spring and seal face.

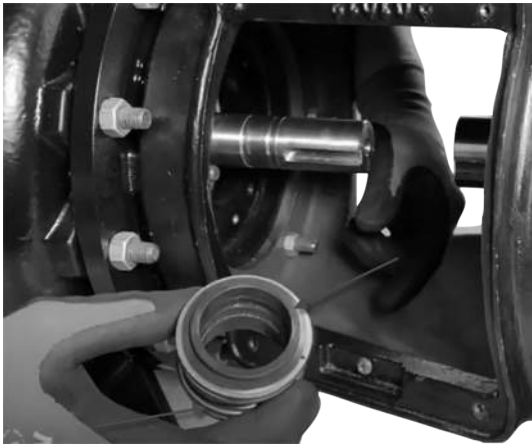

14. Loosen motor from support rails.

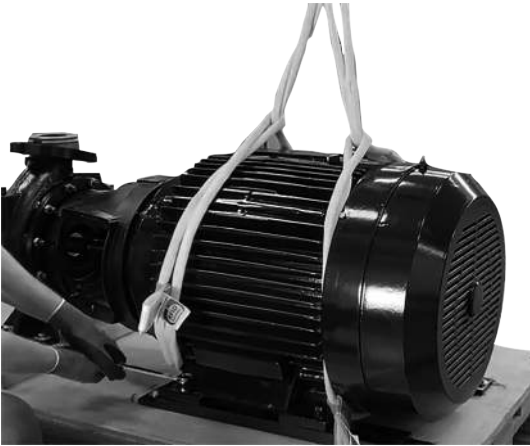

TM080372

15. Loosen motor from motor stool.



TM080373

16. Move motor enough to enable removal of motor stool.



TM080374

17. Loosen and remove motor stool from pump housing.



TM080366

18. Loosen pump cover from pump housing.

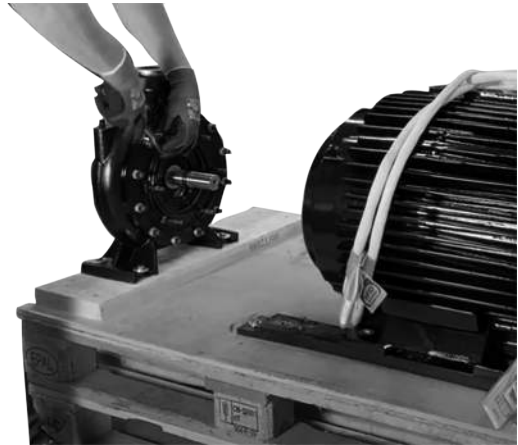

TM080376

19. Note 12 o'clock position of pump cover correlating with the position of seal cover.



20. Remove pump cover and the impeller.



TM080378

21. Note condition of cover O-ring (surface cracks, stiffness and swelling).

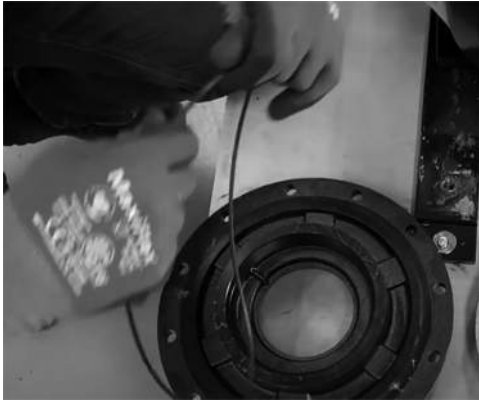

4.2 Checking gap between impeller and pump housing/cover (wear rings)

1. Measure and note the diameter of impeller and pump housing interfaces.



TM080380



Two measurements must be made (positions 12-6 and 3-9). The wear ring may be worn oval due to different directions of radial forces.

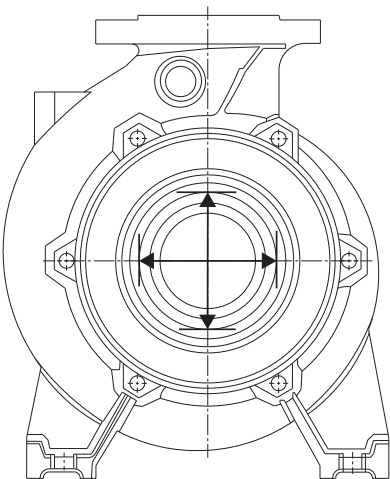

TM080471

2. Measure and note the bore in cover (wear ring, if fitted).

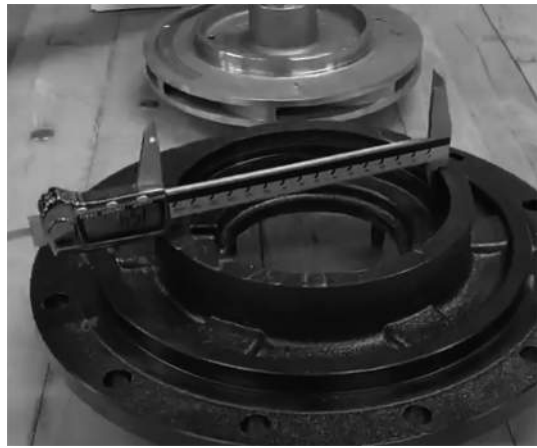

TM080381

3. Measure and note impeller interface to pump housing.

- For maximum gap values, see the dedicated section for Gap between impeller and pump housing/cover (wear rings).



TM080382

Related information

[6.3 Gap between impeller and pump housing/cover \(wear rings\)](#)

4.3 Removing the impeller

1. Remove impeller from shaft, always use soft jaws in the vice



TM080383

4.4 Assembling the pump

1. Assemble impeller to the shaft.
 - Fit impeller key.
 - Impeller eye at the same side as where the impeller is tightened.

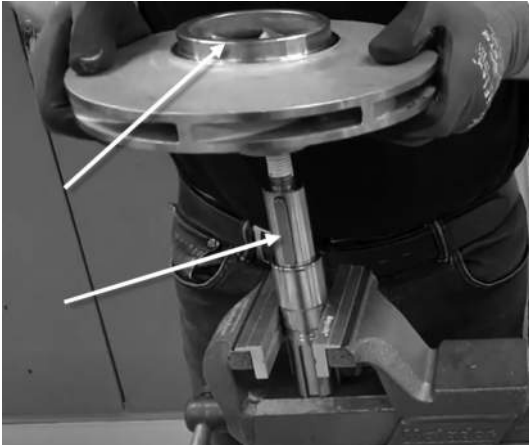

TM080384

2. Assembly sequence – washer, spring washer and nut.



TM080385

3. Tighten impeller nut.



For the required torque, see Torques table.



Apply thread lubricant where torque tightening is required.

Use locally approved thread lubricants, for example, NEVER-SEEZ.

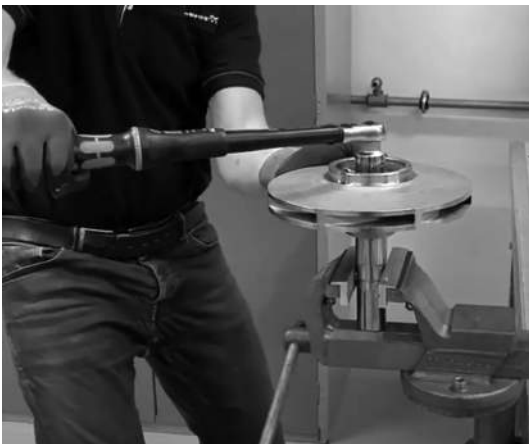

TM080386

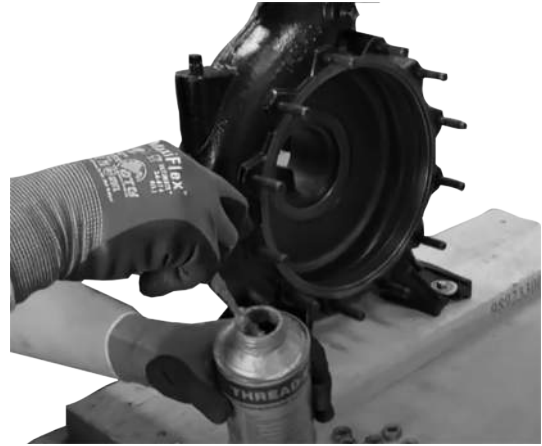

TM080387

4. Check condition and cleanliness for pump cover and O-ring.



Use locally approved lubricants, for example, Rocol Sapphire Aqua SIL.



TM080388

5. Assemble impeller and pump cover.



Marking on the pump cover must point upwards at 12 o'clock position.

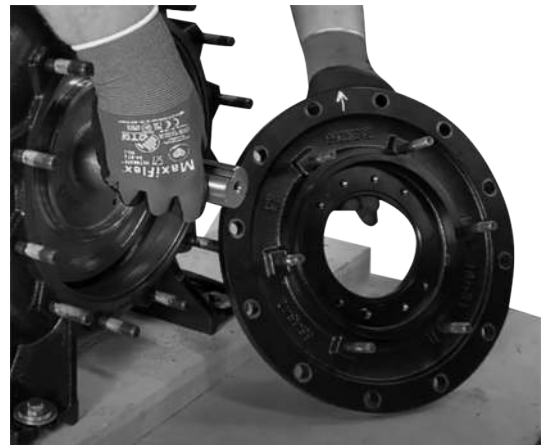

TM080389

6. Tighten pump cover nuts.



For the required torque, see Torques table.

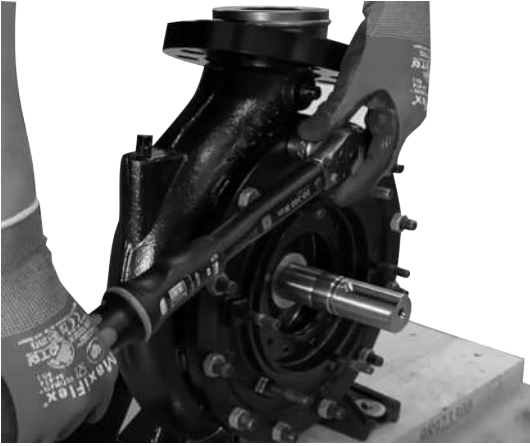

TM080390

7. Assemble motor stool and pump housing, and tighten nuts.



For the required torque, see Torques table.



TM080391



TM080392

8. Assemble motor stool and motor, and tighten nuts.



For the required torque, see Torques table.



TM080393

9. Fit motor to support rails.



TM080394

10. Clean pump shaft, remove rust and debris.



Use steel brush or emery grinding paper.



TM080395

11. Lubricate new shaft seal inside the bellow.



Use locally approved lubricants, for example, Rocol Sapphire Aqua SIL.



TM080396



Make sure NOT to touch the seal face.



TM080397

12. Hand press the shaft seal into position until it rests against the impeller.

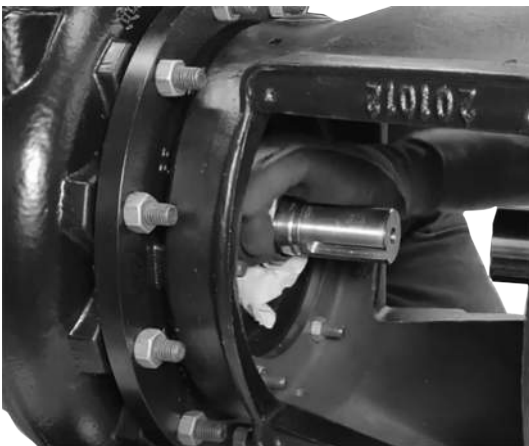

TM080398

13. Check condition and cleanliness of seal cover.



TM080399

14. Lubricate O-rings.



Use locally approved lubricants, for example, Rocol Sapphire Aqua SIL.

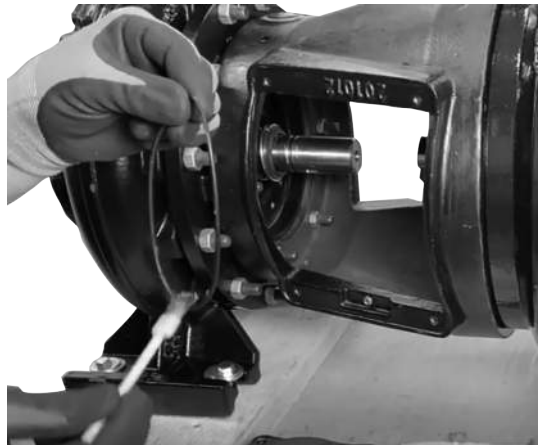

TM080400



TM080401

15. Spray soapy water on seal face of stationary shaft seal part.

! Lubricate seal faces with soapy water, shaft seal with seal face combination xQQx (silicon carbide-silicon carbide) must NEVER run dry.

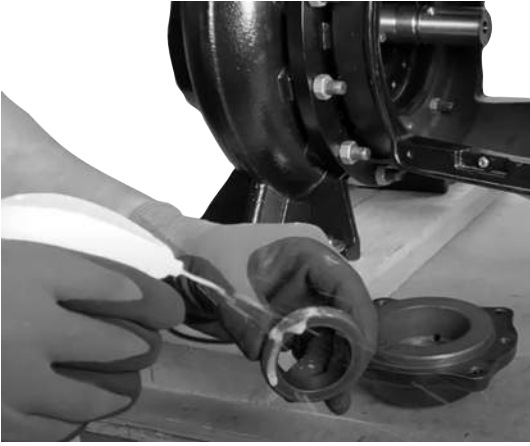

TM080402

17. Apply thread lubricant where torque tightening is required.

! Use locally approved thread lubricants, for example, NEVER-SEEZ.



TM080405

⊘ Make sure NOT to touch the seal faces by hand.



TM080403

18. Make sure that the plug in the seal cover points upwards.

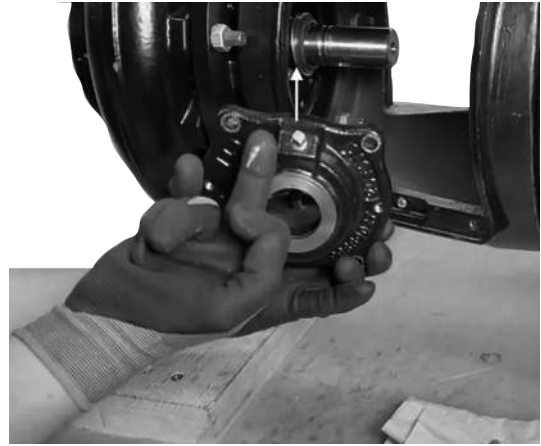

TM080406

16. Use a soft tool to position the stationary seal part in seal cover.



TM080404

19. Tighten the seal cover screws.

! For the required torque, see Torques table.



TM080407

20. Align shaft key slots to the position of 10 o'clock.



TM080408

21. Assemble keys to motor and pump shaft.

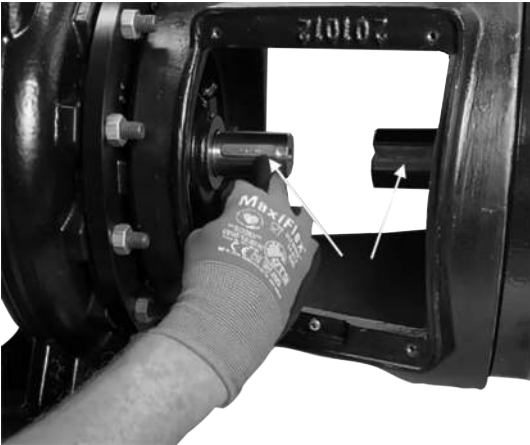

TM080409

22. Use the fork tool to compress the shaft seal spring before assembling the split coupling.

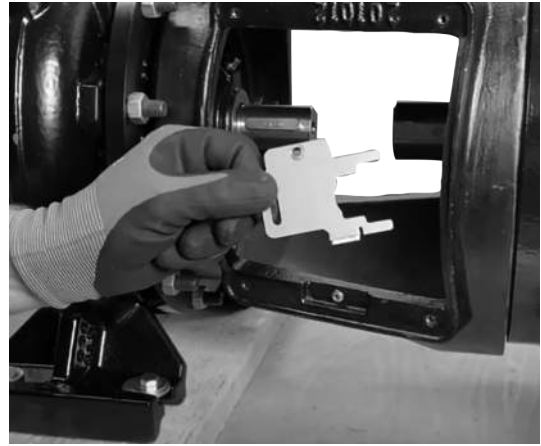

TM080410

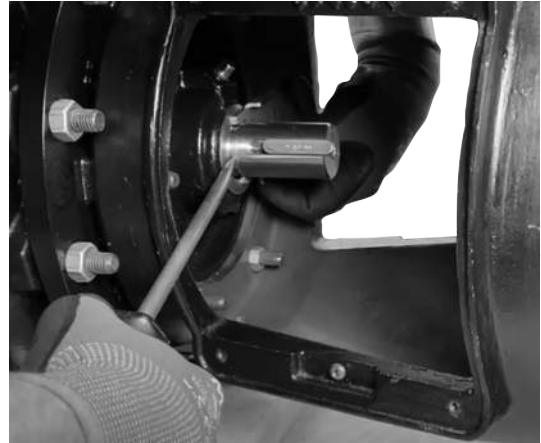

TM080411



Use locally approved thread lubricants, for example, NEVER-SEEZ.



TM080412

23. Check condition and cleanliness of the split coupling pieces.

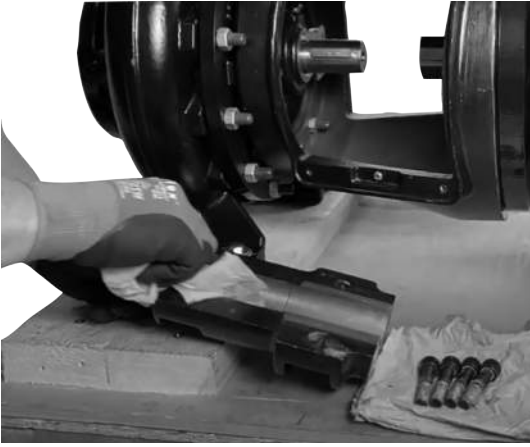

TM080413

26. Tighten by hand, and check the coupling gap.



TM080416

24. Make sure that:

- The split coupling pieces engage with shaft keys.
- The coupling rests against the fork tool flap.

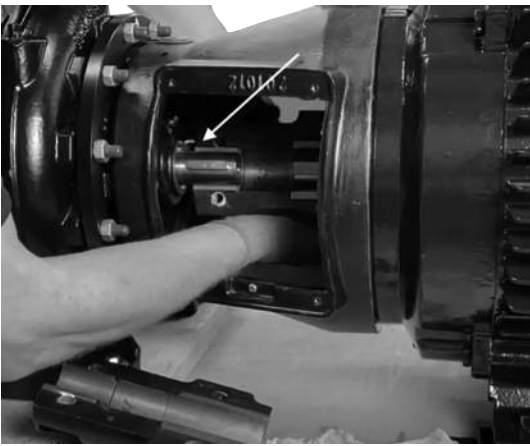

TM080414

27. Remove the fork tool.



TM080417

25. Keep the gap between the coupling pieces equal.



If you do not have an equal gap, loosen the side with the smaller gap and tighten the side with the larger gap until both sides are equal.

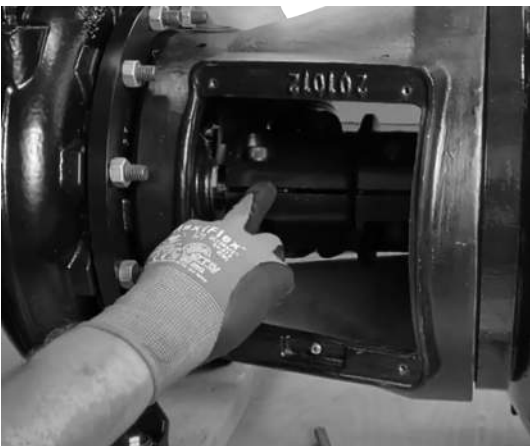

TM080415

28. Cross-tighten coupling screws.



For the required torque, see Torques table.



TM080418

29. Make sure that the shaft runs freely.



30. Tighten the split coupling key set screws.



For the required torque, see Torques table.
Otherwise, hand-tighten the screws plus 15-20 degrees.



TM080421

31. Re-install fork tool in motor stool holder.



TM080422

32. Tighten coupling guard screws.

- Tighten with 5 Nm or hand-tighten.



TM080423

Related information

[6.1 Torque table](#)

5. High pressure seal replacement

Check also the following service videos in association with this task:

How to replace high pressure shaft seal on Grundfos NBS single-stage pump



5.1 Dismantling old seal

1. Remove seal cover.



TM080364

2. If seal cover is stuck to the pump housing cover use two seal cover screws as jacking bolts.



3. Remove stationary part of the shaft seal from seal cover.



TM080367

4. Note O-ring condition on shaft seal and on seal cover (surface cracks, stiffness, swelling).



5. Remove rotating part of the shaft seal (seal face part).

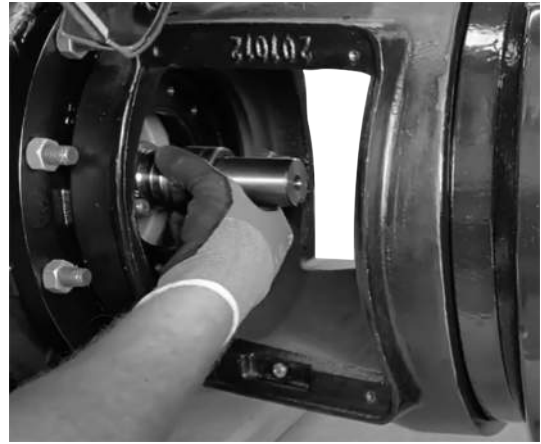

TM080627

6. Check condition of spring and seal face.



TM080628

7. Loosen set screws of rotating seal drive part.

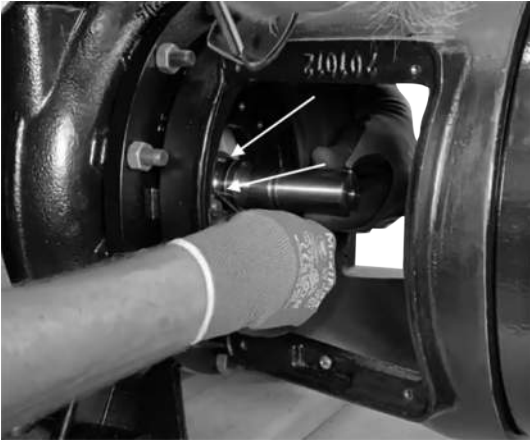

TM080629

One set screw must be 1 mm above surface of driver part.



This set screw can be used to pull out the rotating seal drive part.



TM080630

8. Check condition of O-ring in seal drive part.



TM080631

5.2 Assembling new seal

1. Clean pump shaft, remove rust and debris.



Use steel brush or emery grinding paper.

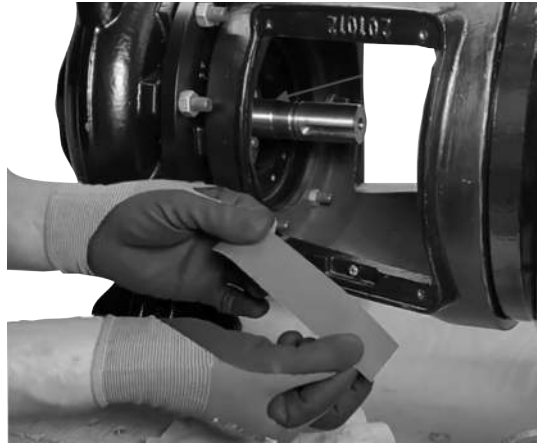

TM080395

2. Check condition and cleanliness of new shaft seal drive parts.

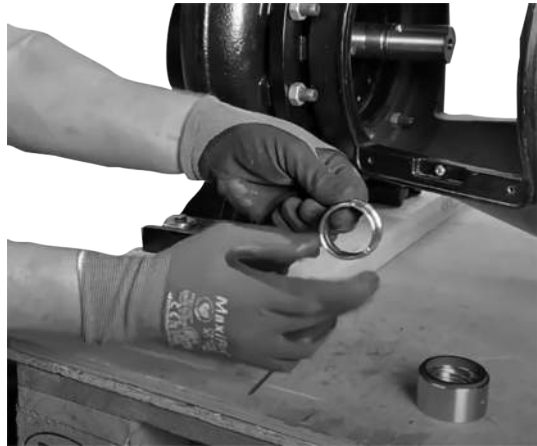

TM080632

3. Lubricate seal faces with soapy water.



Lubricate seal faces with soapy water, shaft seal with seal face combination xQQx (silicon carbide-silicon carbide) must NEVER run dry.



TM080633

4. Note that two set screws are mounted in the driver part.

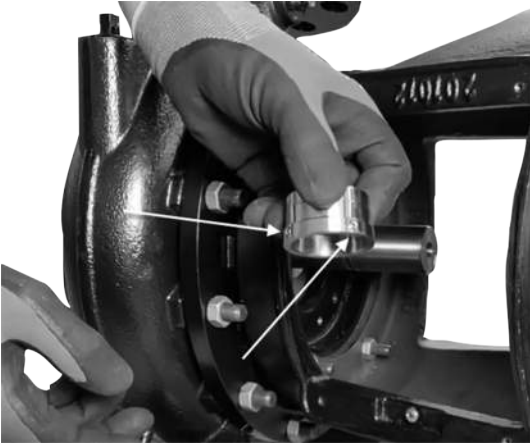

TM080634



Drive part must rest against the impeller.



TM080635

5. Tighten set screws.



Hand tighten plus 15-20 degrees.

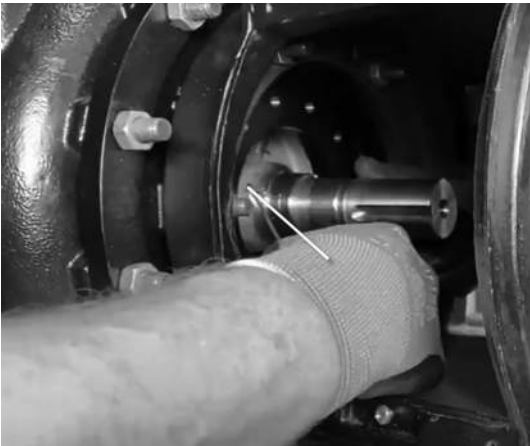

TM080636

6. Check condition and cleanliness of new shaft seal spring and seal face.

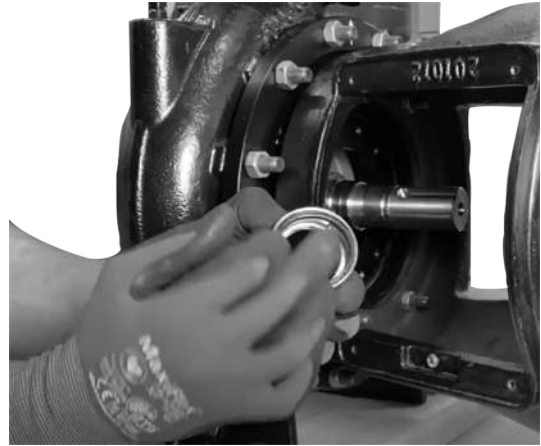

TM080637



Lubricate seal face with soapy water.

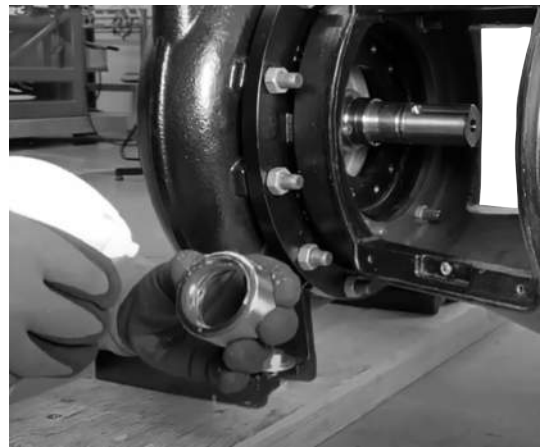

TM080638

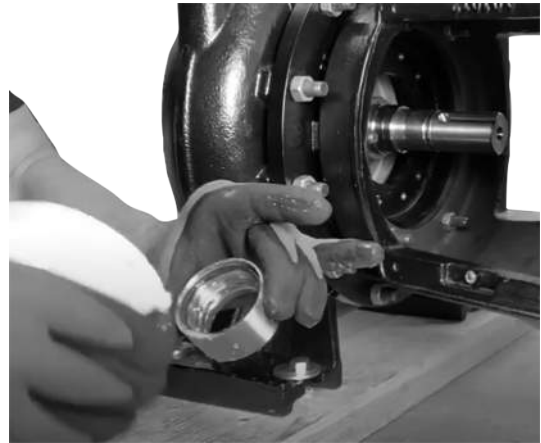

TM080639

7. Make sure that driver parts are engaged.

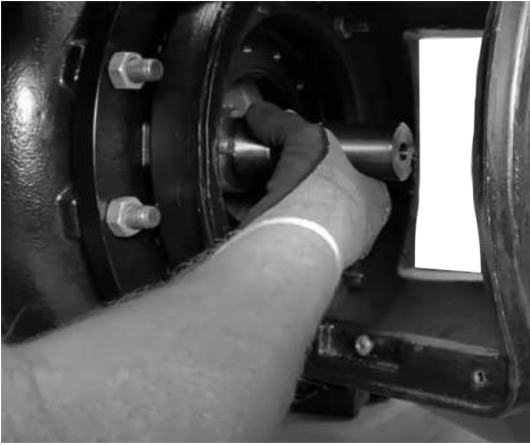

TM080640

8. Check condition and cleanliness of seal cover.



TM080399

9. Lubricate O-rings.



Use locally approved lubricants, for example, Rocol Sapphire Aqua SIL.



TM080400



TM080401

10. Spray soapy water on seal face of stationary shaft seal part .



Lubricate seal faces with soapy water, shaft seal with seal face combination xQQx (silicon carbide-silicon carbide) must NEVER run dry.

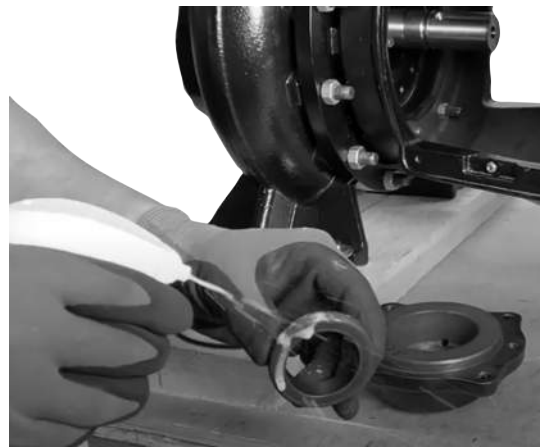

TM080402



Make sure NOT to touch the seal faces by hand.



TM080403

11. Use a soft tool to position stationary seal part in seal cover.



TM080404

12. Apply thread lubricant where torque tightening is required.



Use locally approved thread lubricants, for example, NEVER-SEEZ.



TM080405

13. Make sure that the plug in the seal cover points upwards.

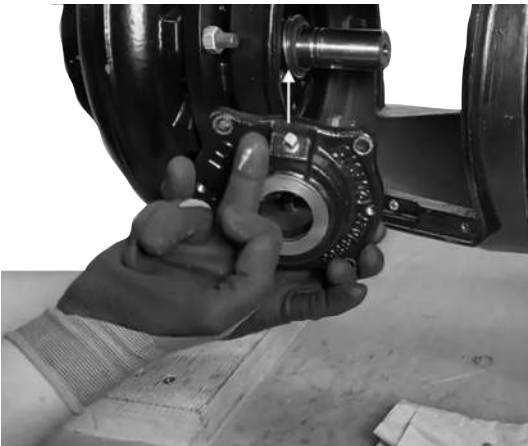

TM080406

6. Reference information

6.1 Torque table

Impeller nuts

Nut	Torque [Nm]
M12	41 +/- 4
M14	65 +/- 7
M18	120 +/- 10
M24	300 +/- 35
M27	300 +/- 35

Pump cover nuts

Nut	Torque [Nm]
M10	45 +/- 9
M12	80 +/- 16
M16	145 +/- 30

Motor stool/pump housing nuts

Nut	Torque [Nm]
M10	40 +/- 8
M1	70 +/- 15
M16	145 +/- 30

Motor stool/motor bolts

Bolt	Torque [Nm]
1/2"	70 +/- 10
5/8"	150 +/- 15

Seal cover screws

Screw	Torque [Nm]
M8	24 +/- 2.4
M10	45 +/- 9

Coupling screws

Screw	Torque [Nm]
M10	85 +/- 8.5
M12	90 +/- 9

Coupling key set screws

Screw	Torque [Nm]
M4	5 +/- 2
M	9 +/- 2
M8	12 +/- 2

Related information

[4.4 Assembling the pump](#)

6.2 Recommended lubricants

- Elastomer Lubricant Vegetable Glycerin
- Anti-seize compound, food grade

6.3 Gap between impeller and pump housing/cover (wear rings)

A leak flow (1) will occur in gap (2) between the rotating impeller and the stationary pump housing when the pump is operating. Leak flow (1) returns to impeller inlet (3) through gap (2).

Thus, the impeller must pump both leak flow (1) and the fluid through the pump from inlet (3) flange to outlet (4) flange. To minimize leak flow (1), an interchangeable wear ring (impeller seal) (A) is mounted.

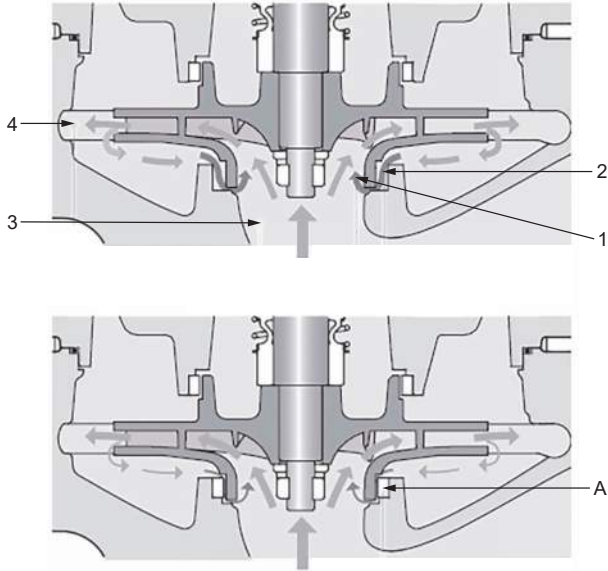

TM080466

We recommend that the seal gap never exceeds the maximum limit curve calculated according to an efficiency loss of maximum 2%.

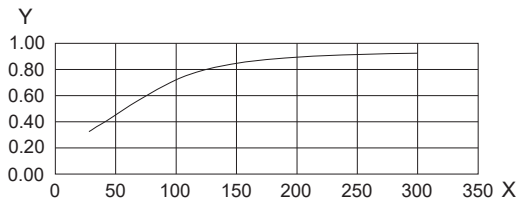

TM080467

X	Outlet DN
Y	Maximum seal gap [mm]

Tolerance table

If the difference exceeds the maximum seal gab according to the above limit curve, the below table informs whether the wear ring or the impeller is worn out.

GG pump housing + bronze wear ring + GG impeller

Wear ring inside			Impeller outside		
Nominal diameter	Max. tolerance	Min. tolerance	Nominal diameter	Max. tolerance	Min. tolerance
76	0.225	0.15	75.95	-0.2	-0.274
76	0.225	0.15	75.95	-0.2	-0.274
76	0.225	0.15	75.95	-0.2	-0.274
63	0.22	0.15	62.95	-0.19	-0.264
90	0.245	0.17	89.95	-0.22	-0.307
90	0.245	0.17	89.95	-0.22	-0.307
100	0.245	0.17	99.95	-0.22	-0.307
100	0.245	0.17	99.95	-0.22	-0.307
100	0.245	0.17	99.95	-0.22	-0.307
112	0.25	0.17	111.95	-0.24	-0.327
112	0.25	0.17	111.95	-0.24	-0.327
112	0.25	0.17	111.95	-0.24	-0.327
122	0.265	0.185	121.95	-0.26	-0.36
130	0.265	0.185	129.95	-0.26	-0.36
130	0.265	0.185	129.95	-0.26	-0.36
154	0.275	0.195	153.95	-0.28	-0.38
154	0.275	0.195	153.95	-0.28	-0.38
185	0.3	0.21	184.95	-0.34	-0.455
185	0.3	0.21	184.95	-0.34	-0.455
185	0.3	0.21	184.95	-0.34	-0.455
200	0.31	0.22	199.95	-0.34	-0.455
144	0.275	0.195	143.95	-0.28	-0.38
224	0.31	0.22	223.95	-0.38	-0.495
174	0.3	0.21	173.95	-0.31	-0.41
224	0.31	0.22	223.95	-0.38	-0.495
210	0.31	0.22	209.95	-0.38	-0.495
222	0.25	0.05	221.95	-0.38	-0.495
230	0.25	0.05	229.95	-0.42	-0.54
240	0.25	0.05	239.95	-0.42	-0.535
260	0.25	0.05	259.95	-0.48	-0.61
250	0.25	0.05	249.95	-0.42	-0.535

SS pump housing + SS wear ring + SS impeller

Wear ring inside			Impeller outside		
Nominal diameter	Max. tolerance	Min. tolerance	Nominal diameter	Max. tolerance	Min. tolerance
76.5	0.074	0	76	-0.2	-0.274
76.5	0.074	0	76	-0.2	-0.274
76.5	0.074	0	76	-0.2	-0.274
63.5	0.74	0	63	-0.19	-0.264
90.55	0.087	0	90	-0.22	-0.307
90.55	0.087	0	90	-0.22	-0.307
100.55	0.087	0	100	-0.22	-0.307
100.55	0.087	0	100	-0.22	-0.307
100.55	0.087	0	100	-0.22	-0.307
112.55	0.087	0	112	-0.24	-0.327
112.55	0.087	0	112	-0.24	-0.327
112.55	0.087	0	112	-0.24	-0.327
122.6	0.1	0	122	-0.26	-0.36
130.6	0.1	0	130	-0.26	-0.36
130.6	0.1	0	130	-0.26	-0.36
154.6	0.1	0	154	-0.28	-0.38
154.6	0.1	0	154	-0.28	-0.38
185.65	0.115	0	185	-0.34	-0.455
185.65	0.115	0	185	-0.34	-0.455
185.65	0.115	0	185	-0.34	-0.455
200.65	0.115	0	200	-0.34	-0.455
144.6	0.1	0	144	-0.28	-0.38
224.65	0.115	0	224	-0.38	-0.495
174.6	0.1	0	174	-0.31	-0.41
224.65	0.115	0	224	-0.38	-0.495
210.65	0.115	0	210	-0.38	-0.495

Related information

[4.2 Checking gap between impeller and pump housing/cover \(wear rings\)](#)



6.4 Related documents

You find further product information about NBS/NBSE in the following documents. All documents are available in Grundfos Product Center: www.grundfos.com > International website > Grundfos Product Center.

Title	Publication number
NBS/NBSE installation and operating instructions	99932034
NBS/NBSE service kit catalogue	-

6.5 Service videos

You can find video instructions for the service of NBS/NBSE pumps by exploring the following QR codes/links:

Video	QR code
How to dismantle and assemble Grundfos NBS single-stage pump	
How to replace low pressure shaft seal on Grundfos NBS single-stage pump	
How to replace high pressure shaft seal on Grundfos NBS single-stage pump	

7. Fault finding



DANGER Electric shock

Death or serious personal injury

- Before removing the terminal box cover and before removing or dismantling the pump, make sure that the power supply has been switched off and that it cannot be accidentally switched on again. Use logout-tagout if available.

WARNING Escaping liquid

Death or serious personal injury



- Pay attention to the orientation of the vent hole to ensure that the escaping liquid does not cause personal injury or damage to the motor or other components.
- In hot-liquid installations, pay special attention to the risk of personal injury caused by scalding hot liquid.
- In cold-liquid installations, pay special attention to the risk of personal injury caused by cold liquid.



CAUTION Cold surfaceor Hot surface

Minor or moderate personal injury



- When pumping hot or cold liquids, make sure that no one can accidentally come into contact with hot or cold surfaces.

Fault	Cause	Remedy
1. The pump delivers no or too little liquid.	a) The electrical connection is wrong, for instance two phases.	<ol style="list-style-type: none"> 1. Check the electrical connection. 2. Remedy, if necessary.
	b) The direction of rotation is wrong.	<ul style="list-style-type: none"> • Interchange two phases of the power supply.
	c) There is air in inlet pipe.	<ul style="list-style-type: none"> • Vent the inlet pipe or the pump.
	d) The counterpressure is too high.	<ol style="list-style-type: none"> 1. Set the duty point according to the flow and head that the pump is selected for. 2. Check the system for debris. 3. Clean the system, if necessary.
	e) The inlet pressure is too low.	<ul style="list-style-type: none"> • Increase the liquid level on the inlet side. • Open the isolating valve in the inlet pipe. • Make sure that all the conditions in section Pipes are complied with.
	f) The inlet pipe or impeller is blocked by debris.	<ul style="list-style-type: none"> • Clean the inlet pipe or pump.
	g) The pump draws in air due to a defective seal.	<ol style="list-style-type: none"> 1. Check the pipeline seals, pump housing gaskets and shaft seals. 2. Replace gaskets and seals, if necessary.
	h) The pump draws in air due to low liquid level.	<ol style="list-style-type: none"> 1. Increase the liquid level on the inlet side. 2. Keep the liquid level as constant as possible.
2. The motor-protective circuit breaker has tripped because the motor is overloaded.	a)The pump is blocked by debris.	<ul style="list-style-type: none"> • Clean the pump.
	b) The pump is running above rated duty point.	<ul style="list-style-type: none"> • Set the duty point according to the flow and head that the pump is selected for.
	c) The density or viscosity of the liquid is higher than specified upon order.	<ul style="list-style-type: none"> • If less flow is sufficient, reduce the flow on the outlet side. • If less flow is insufficient, fit a more powerful motor.
	d) The motor-protective circuit breaker overload setting is incorrect.	<ol style="list-style-type: none"> 1. Check the setting of the motor-protective circuit breaker. 2. Adjust the setting if necessary.
	e)The motor runs on two phases.	<ol style="list-style-type: none"> 1. Check the electrical connection. 2. Replace the fuse, if defective.
	f) The motor may be faulty	<ol style="list-style-type: none"> 1. Check the motor. 2. Replace the motor if necessary.

Fault	Cause	Remedy
3. The pump makes too much noise. The pump runs unevenly and vibrates.	a) The inlet pressure is too low, resulting in cavitation in the pump.	<ul style="list-style-type: none"> • Increase the liquid level on the inlet side. • Open the isolating valve in the inlet pipe. • Make sure that all the conditions in section Pipes are complied with.
	b) There is air in the inlet pipe or pump.	<ul style="list-style-type: none"> • Vent the inlet pipe or the pump.
	c) The counterpressure is lower than specified.	<ul style="list-style-type: none"> • Set the duty point according to the flow and head that the pump is selected for.
	d) The pump draws in air due to low liquid level.	<ul style="list-style-type: none"> • Increase the liquid level on the inlet side and keep it as constant as possible.
	e) The impeller is out of balance or the impeller blades are clogged.	<ol style="list-style-type: none"> 1. Clean the impeller. 2. Check the impeller blades, clean them if necessary.
	f) The split coupling is out of balance.	<ol style="list-style-type: none"> 1. Check coupling gap and that set screws in split coupling are tightened.
		<ol style="list-style-type: none"> 2. Disassemble split coupling to inspect keys and keyways and their alignment with coupling pieces.
	g) The inner parts are worn.	<ul style="list-style-type: none"> • Replace the defective parts.
	h) The pump is stressed by the pipes thus causing starting noise.	<ul style="list-style-type: none"> • Mount the pump so that it is not stressed. • Support the pipes.
	i) The bearings are defective.	<ul style="list-style-type: none"> • Replace the bearings.
	j) The motor fan is defective.	<ul style="list-style-type: none"> • Replace the fan.
	k) There are foreign bodies in the pump.	<ul style="list-style-type: none"> • Clean the pump.
l) Frequency converter operation causes noise.	<ul style="list-style-type: none"> • Find the different remedies in Frequency converter operation section. See section Frequency converter operation. 	
4. The pump, connections or mechanical shaft seal is leaking.	a) The pump is stressed by the pipes which causes leaks in the pump housing or at connections.	<ul style="list-style-type: none"> • Mount the pump so that it is not stressed. • Support the pipes.
	b) Pump housing gaskets and gaskets at connections are defective.	<ul style="list-style-type: none"> • Replace the pump housing gaskets or gaskets at connections.
	c) The mechanical shaft seal is dirty or stuck together.	<ul style="list-style-type: none"> • Check and clean the mechanical shaft seal.
	d) The mechanical shaft seal is defective.	<ul style="list-style-type: none"> • Replace the mechanical shaft seal.
	e) The shaft surface is defective.	<ul style="list-style-type: none"> • Replace the shaft.
5. The temperature in the pump or motor is too high.	a) There is air in the inlet pipe or pump.	<ol style="list-style-type: none"> 1. Vent the inlet pipe or the pump. 2. Fill up the inlet pipe and the pump again.
		<ul style="list-style-type: none"> • Increase the liquid level on the inlet side. • Open the isolating valve in the inlet pipe. • Make sure that all the conditions in section Pipes are complied with.
	b) The inlet pressure is too low.	<ul style="list-style-type: none"> • Increase the liquid level on the inlet side. • Open the isolating valve in the inlet pipe. • Make sure that all the conditions in section Pipes are complied with.
	c) The bearings are lubricated with too little, too much or unsuitable lubricant.	<ul style="list-style-type: none"> • Replenish, reduce or replace the lubricant.
	d) The axial pressure is too high.	<ol style="list-style-type: none"> 1. Check the relief holes of the impeller on the inlet side. 2. Clean the holes, if necessary
	e) The motor-protective circuit breaker is defective or the setting is incorrect.	<ol style="list-style-type: none"> 1. Check the setting of the motor-protective circuit breaker. 2. Replace the circuit breaker if necessary.
f) The motor is overloaded.	<ul style="list-style-type: none"> • Reduce the flow rate. 	

8. Exploded drawings

Center-line outlet

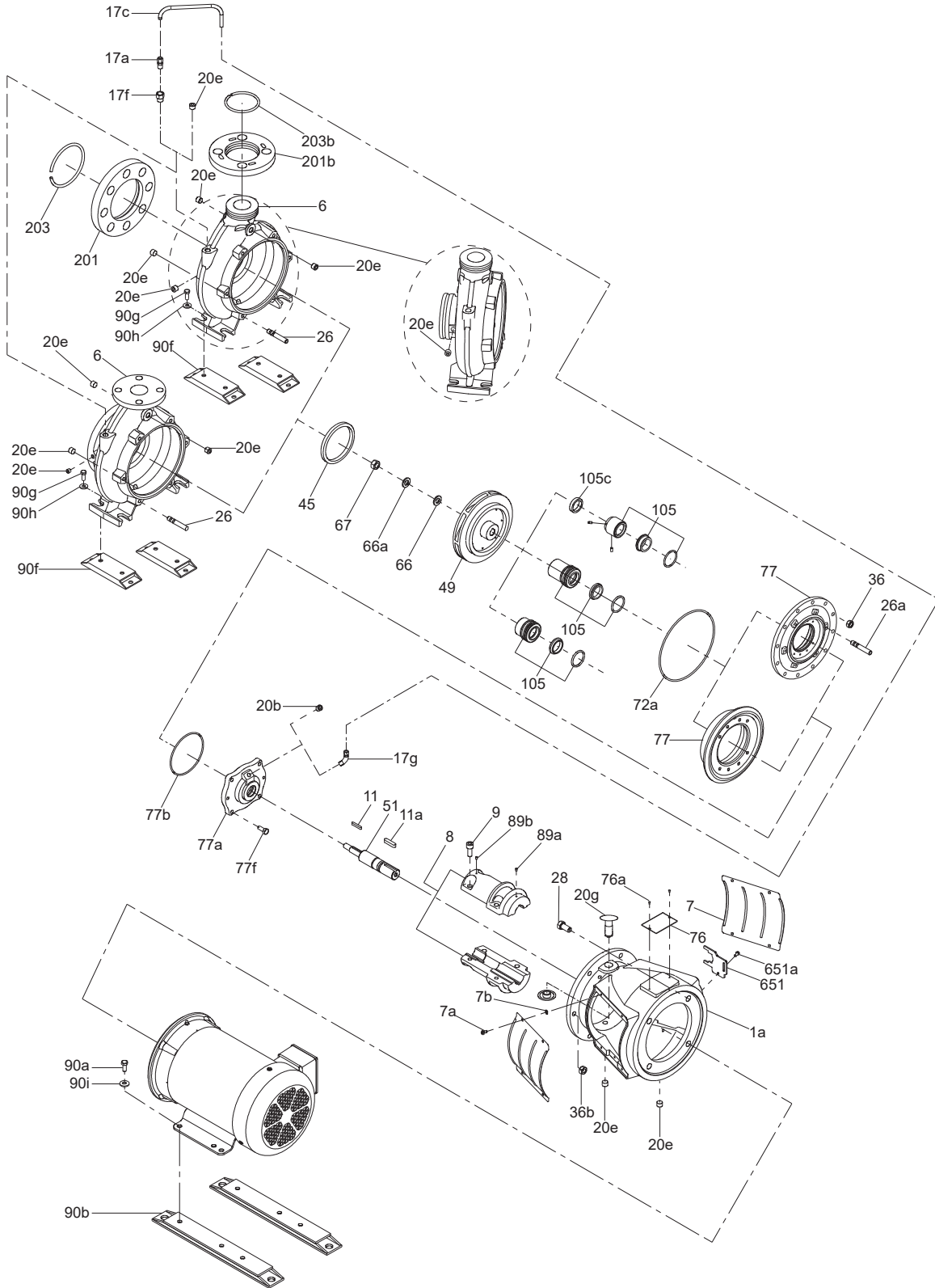

Tangential outlet

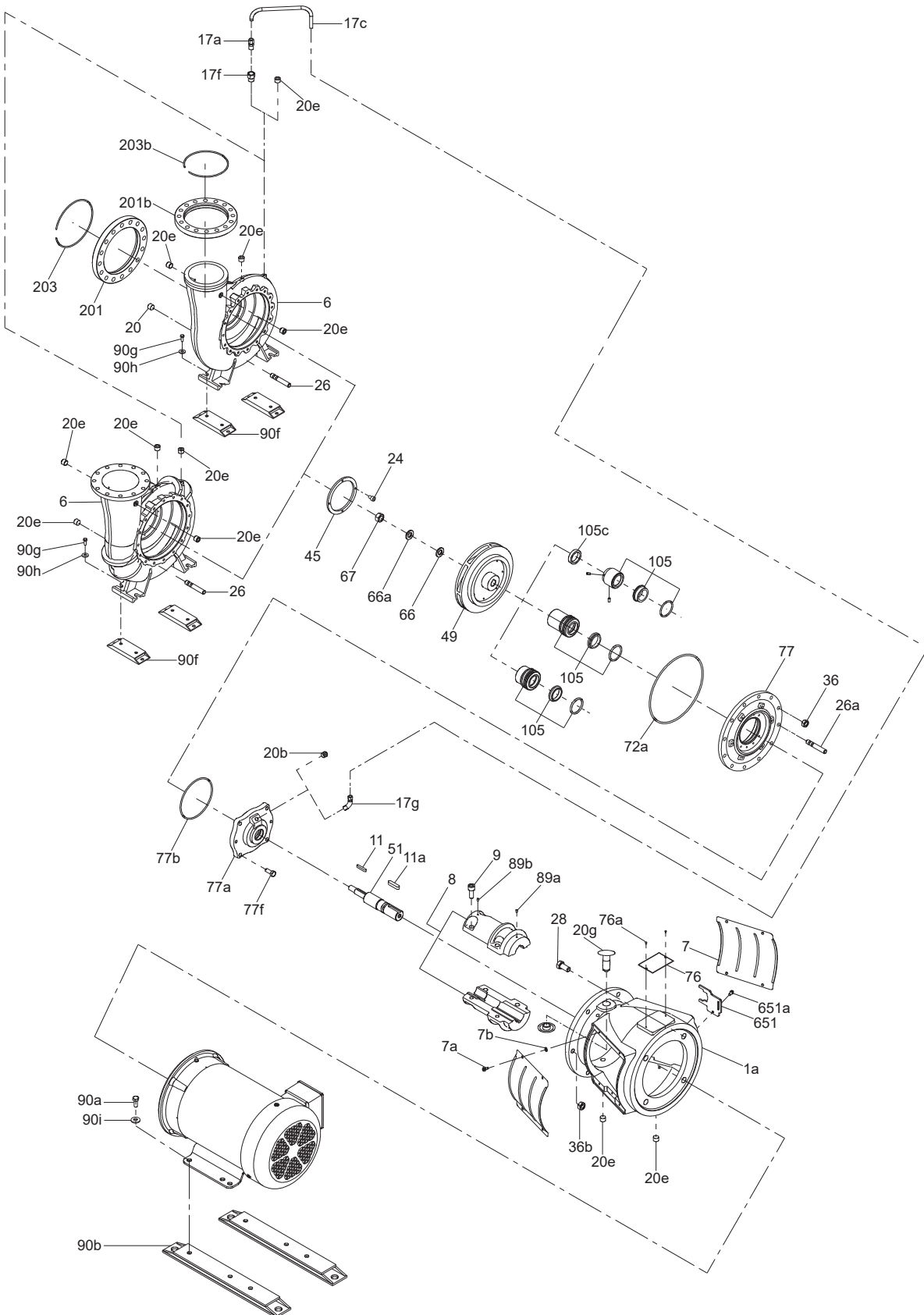

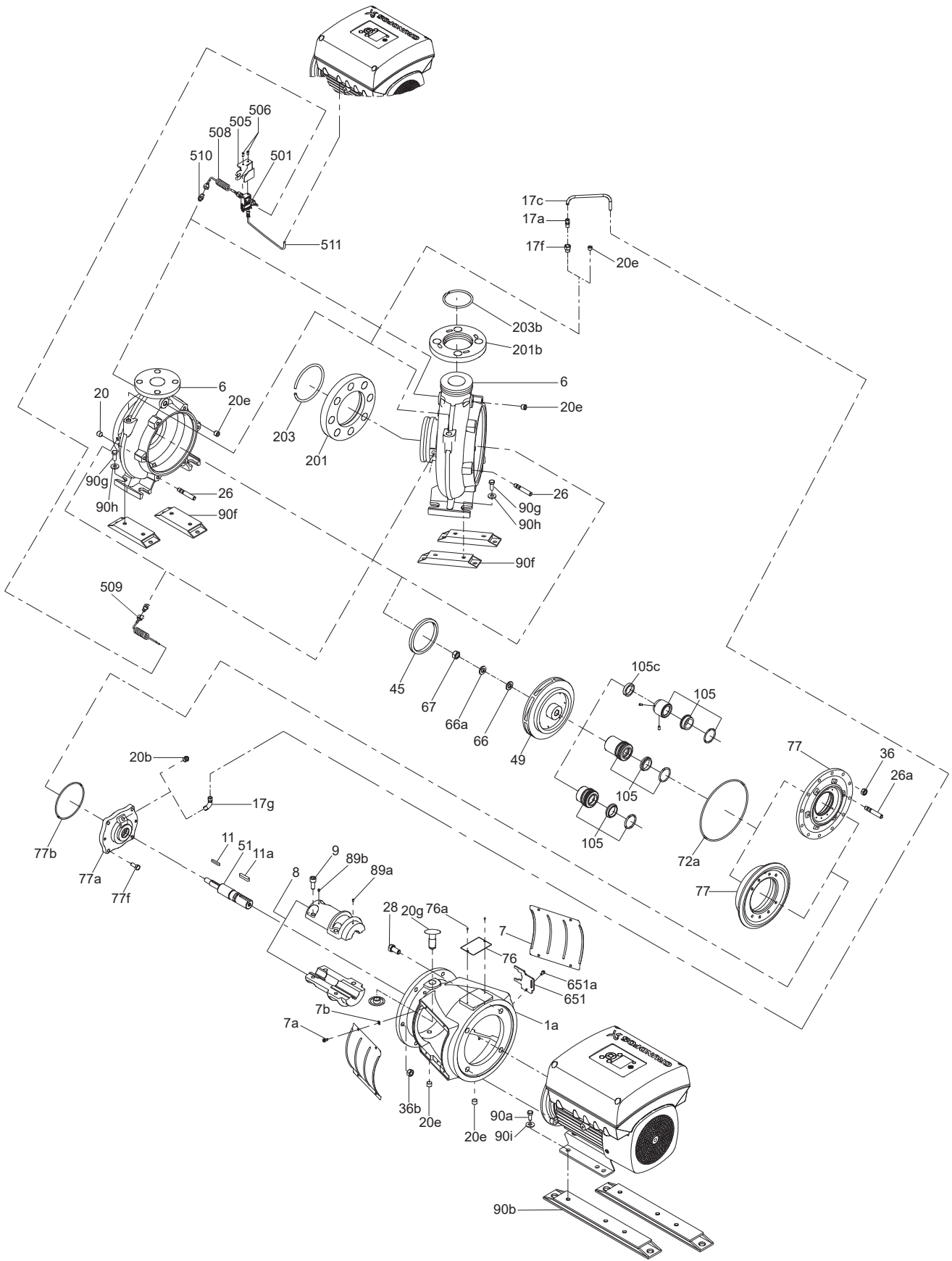

TM07568

92622616 09.2021
ECM: 1320672

Trademarks displayed in this material, including but not limited to Grundfos, the Grundfos logo and "be think innovate" are registered trademarks owned by The Grundfos Group. All rights reserved. © 2021 Grundfos Holding A/S, all rights reserved.

