

CMBE

Installation and operating instructions



WATER QUALITY

Drinking Water System Component
NSF / ANSI 61
NSF / ANSI 372



Original installation and operating instructions.

CONTENTS

	Page
1. Limited warranty	2
2. Symbols used in this document	3
3. Introduction	3
4. Approvals	3
4.1 Delivery and handling	4
4.2 Applications	4
4.3 Identification	5
5. Installation	6
5.1 Mounting	6
5.2 Cable entries	6
5.3 Ensuring motor cooling	6
5.4 Outdoor installation	6
5.5 Drain holes	6
6. Electrical installation	7
6.1 Protection against electric shock, indirect contact	7
6.2 Mains supply	7
7. Operating conditions	8
7.1 Maximum number of starts and stops	8
7.2 Ambient temperature	8
7.3 Installation altitude	8
7.4 Air humidity	8
7.5 Motor cooling	8
7.6 Pumps with factory-fitted pressure sensor	8
8. Startup	8
8.1 Positive inlet pressure start-up procedure	8
8.2 Flooded suction and suction lift start up procedures	8
9. User interfaces	9
9.1 Standard control panel	9
10. Grundfos Eye	10

**Warning**

Prior to installation, read these installation and operating instructions. Installation and operation must comply with local regulations and accepted codes of good practice.

**Warning**

This booklet should be left with the owner of the pump for future reference and information regarding its operation.

1. Limited warranty

Products manufactured by GRUNDFOS PUMPS CORPORATION (Grundfos) are warranted to the original user only to be free of defects in material and workmanship for a period of 24 months from date of installation, but not more than 30 months from date of manufacture. Grundfos' liability under this warranty shall be limited to repairing or replacing at Grundfos' option, without charge, F.O.B. Grundfos' factory or authorized service station, any product of Grundfos' manufacture. Grundfos will not be liable for any costs of removal, installation, transportation, or any other charges which may arise in connection with a warranty claim. Products which are sold but not manufactured by Grundfos are subject to the warranty provided by the manufacturer of said products and not by Grundfos' warranty. Grundfos will not be liable for damage or wear to products caused by abnormal operating conditions, accident, abuse, misuse, unauthorized alteration or repair, or if the product was not installed in accordance with Grundfos' printed installation and operating instructions.

To obtain service under this warranty, the defective product must be returned to the distributor or dealer of Grundfos' products from which it was purchased together with proof of purchase and installation date, failure date, and supporting installation data. Unless otherwise provided, the distributor or dealer will contact Grundfos or an authorized service station for instructions. Any defective product to be returned to Grundfos or a service station must be sent freight prepaid; documentation supporting the warranty claim and/or a Return Material Authorization must be included if so instructed.

GRUNDFOS WILL NOT BE LIABLE FOR ANY INCIDENTAL OR CONSEQUENTIAL DAMAGES, LOSSES, OR EXPENSES ARISING FROM INSTALLATION, USE, OR ANY OTHER CAUSES. THERE ARE NO EXPRESS OR IMPLIED WARRANTIES, INCLUDING MERCHANTABILITY OR FITNESS FOR A PARTICULAR PURPOSE, WHICH EXTEND BEYOND THOSE WARRANTIES DESCRIBED OR REFERRED TO ABOVE.

Some jurisdictions do not allow the exclusion or limitation of incidental or consequential damages and some jurisdictions do not allow limit actions on how long implied warranties may last. Therefore, the above limitations or exclusions may not apply to you. This warranty gives you specific legal rights and you may also have other rights which vary from jurisdiction to jurisdiction.

2. Symbols used in this document



Warning
If these safety instructions are not observed, it may result in personal injury.



Warning
If these instructions are not observed, it may lead to electric shock with consequent risk of serious personal injury or death.



Warning
The surface of the product may be so hot that it may cause burns or personal injury.



Caution
If these safety instructions are not observed, it may result in malfunction or damage to the equipment.



Note
Notes or instructions that make the job easier and ensure safe operation.

3. Introduction

These installation and operating instructions are a supplement to the installation and operating instructions for the corresponding standard CM (E) pumps.

For instructions not mentioned specifically in this manual, see the installation and operating instructions for the standard pump.

Grundfos CMBE is designed on the CME platform. CMBE operates at 4000 rpm producing a unique performance curve from the standard CME.

CMBE comes complete with 5 way tee, pressure tank, pressure sensor, pressure gauge, and non return valve.

CMBE has built-in dry run protection.

The pumps have a built-in PI controller and are set up with a pressure sensor enabling the control of the pump discharge pressure.

The pumps have been factory-set to constant-pressure control mode. The pumps are typically used to keep a constant pressure in variable-demand systems.



TM06 0793 0214

4. Approvals

Drinking Water Certifications



UL Electrical

1 x 230 V CMBE models: UL Listing for Packaged Pumping System



UL Electrical

1 x 115 V CMBE models: Motor is UL Recognized



TM06 3626 0215

TM06 3627 0215

TM06 4295 0515

4.1 Delivery and handling

4.1.1 Delivery

Examine the pump carefully to make sure no damage has occurred during shipment.

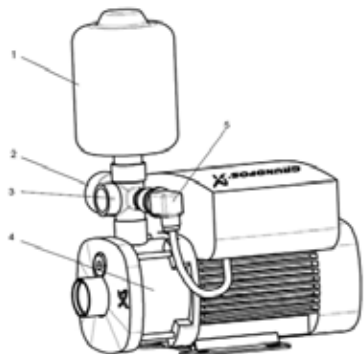

TM06 0794 0214

Fig. 1 CMBE

Pos.	Component
1	Diaphragm tank
2	Pressure gauge 0-145 psi (0-10 bar)
3	Five way fitting with integrated non-return valve
4	CME pump
5	Pressure sensor

4.1.2 Handling

Caution *The pump should remain the packing until installation.*

The packing is specially designed to protect it from damage.

During unpacking and prior to installation, make sure that the pump is not dropped or mishandled.

4.2 Applications

The CMBE is designed for domestic and commercial constant pressure applications.

4.2.1 Pumped liquids

The CMBE is designed for pumping water and other thin, non-aggressive and non-explosive liquids, not containing solid particles or fibers. If the pump has been used for dirty liquids; e.g., pool water, it must be flushed through with clean water immediately after use.

4.3 Identification

4.3.1 Type key

Example	CMBE	1	44	I	U	C	I	D	E
Type range CMBE: CME booster with integrated frequency converter									
Rated flow rate At 50 Hz [m ³ /h]									
Max. head [m]									
Materials in contact with the pumped liquid									
I: Sleeve EN 1.4301/AISI 304									
Pump shaft EN 1.4301/AISI 304									
Impellers/chambers EN 1.4301/AISI 304									
Pressure manager PP 30GF									
Pressure tank EPDM/steel/PP/Butyl									
5-way valve EN 1.4301/AISI 304									
Supply voltage									
X: 1 x 115 V, 60 Hz									
U: 1 x 200-240, V 60 Hz									
Motor									
C: High-efficiency motor with frequency converter (IP55)									
Mains cable and plug									
B: U.S. plug NEMA 5-15 (1 x 115 V m, 60 Hz, CMBE)									
I: Without cable and plug, (1 x 200 - 240 V, 60 Hz CMBE)									
Controller									
D: Integrated frequency converter									
E: Thread type and size									

4.3.2 Nameplate

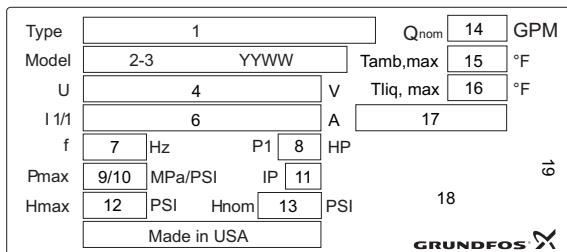

Fig. 2 Nameplate

Pos.	Description
1	Combined product type and conf.
2	Code of model
3	Material number
4	Supply voltage
6	Full load Amps
7	Frequency
8	Power input (HP)
9	Max. system pressure (MPa)
10	Max. system pressure (psi)
11	IP Class
12	Maximum head (psi)
13	Nominal head (psi)
14	Nominal flow rate (gpm)
15	Max. ambient temp. (°F)
16	Max. liquid temp. (°F)
17	EFF
18	Combined Approvals
19	Nameplate layout

TM06 3510 0515

5. Installation



Warning

Installation and operation must comply with local regulations and accepted codes of good practice.



Warning

All electrical work should be performed by a qualified electrician in accordance with the latest edition of the National Electrical Code, local codes and regulations.



Warning

Verify that the electrical supply has been switched OFF before making any connections. The pump should not be connected to the electrical system until it has been properly installed in the piping system.

We recommend that installation is carried out by skilled personnel with technical qualifications required by the specific legislation in force.

The term skilled personnel means persons whose training, experience and instruction, as well as their knowledge of the respective standards and requirements for accident prevention and working conditions, have been approved by the person in charge of plant safety, authorizing them to perform all the necessary activities, during which they are able to recognize and avoid all dangers.

5.1 Mounting

The pump must be secured to a solid foundation by bolts through the holes in the flange or the base plate.

5.2 Cable entries

The motor has four M20 screwed cable entries fitted with blind plugs from factory.

The following cable glands are included:

- 2 x M20 cable gland, cable diameter $\varnothing 5$ mm
- 1 x M20 cable gland, cable diameter $\varnothing 7-14$ mm.

5.3 Ensuring motor cooling

In order to ensure sufficient cooling of the motor, the distance (D) between the end of the fan cover and a wall or other fixed objects must always be at least 2 inches (50 mm), irrespective of motor size. See fig. 1.

Note

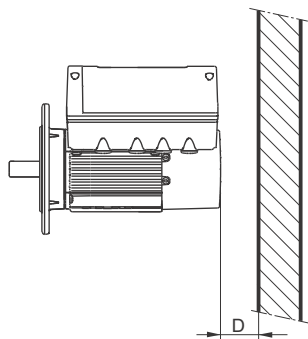

Fig. 3 Minimum distance (D) from the motor to a wall or other fixed objects

TM05 5236 3512

5.4 Outdoor installation

When installed outdoors, the motor must be provided with a suitable cover to avoid condensation on the electronic components. See fig. 2.

Note

When fitting a cover to the motor, observe the guideline in section 5.3 Ensuring motor cooling.

The cover must be sufficiently large to ensure that the motor is not exposed to direct sunlight, rain or snow. Grundfos does not supply covers. We therefore recommend that you have a cover built for the specific application. In areas with high air humidity, we recommend that you enable the built-in standstill heating function.

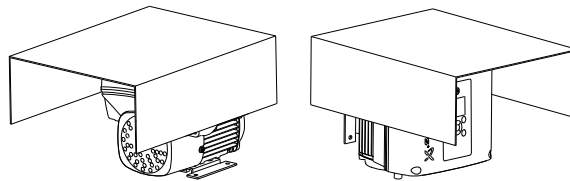

TM05 3496 3512

Fig. 4 Examples of covers (not supplied by Grundfos)

5.5 Drain holes

When the motor is installed in moist surroundings or areas with high air humidity, the bottom drain hole should be open.

The enclosure class of the motor will then be lower. The open drain hole helps prevent condensation in the motor as it will make the motor self-venting and allow water and humid air to escape.

The motor has a plugged drain hole on the drive side. The flange can be turned 90 ° to both sides or 180 °.

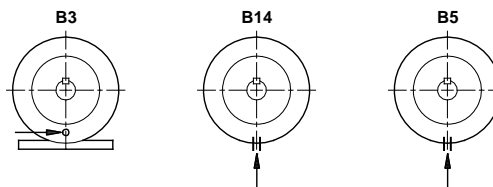

TM02 9037 1604

Fig. 5 Drain holes

6. Electrical installation

Carry out the electrical connection according to local regulations. Check that the supply voltage and frequency correspond to the values stated on the nameplate.

Warning

Do not make any connections in the terminal box unless the power supply has been switched off for at least 5 minutes.



Make sure that the power supply cannot be accidentally switched on.

The motor must be earthed and protected against indirect contact in accordance with local regulations.

If the power supply cable is damaged, it must be replaced by the manufacturer, the manufacturer's service partner or a similarly qualified person.

The user or the installer is responsible for the installation of correct earthing and protection according to local regulations. All operations must be carried out by a qualified electrician.

Note

6.1 Protection against electric shock, indirect contact



Warning

The motor must be earthed and protected against indirect contact in accordance with local regulations.

Protective-earth conductors must always have a yellow/green (PE) or yellow/green/blue (PEN) color marking.

6.1.1 Protection against mains voltage transients

The motor is protected against mains voltage transients in accordance with EN 61800-3.

6.1.2 Motor protection

The motor requires no external motor protection. The motor incorporates thermal protection against slow overloading and blocking.

6.2 Mains supply

6.2.1 Single-phase supply voltage

- 1 x 115 V - 10 %/+ 10 %, 60 Hz, PE.
- 1 x 200-240 V - 10 %/+ 10 %, 50/60 Hz, PE.

Check that the supply voltage and frequency correspond to the values stated on the nameplate.

If the motor is supplied through an IT network, a dedicated IT network motor should be used. Contact Grundfos.

Note

1 x 200-240 V models

The wires in the motor terminal box must be as short as possible. Excepted from this is the separated earth conductor which must be so long that it is the last one to be disconnected in case the cable is inadvertently pulled out of the cable entry.

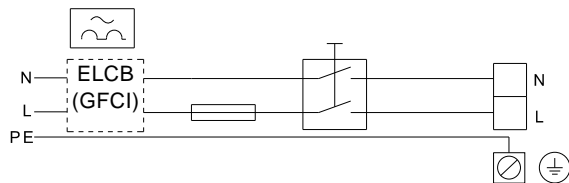

Fig. 6 Example of a direct-connected motor with disconnect switch, backup fuse and additional protection

TM05 4034 1912

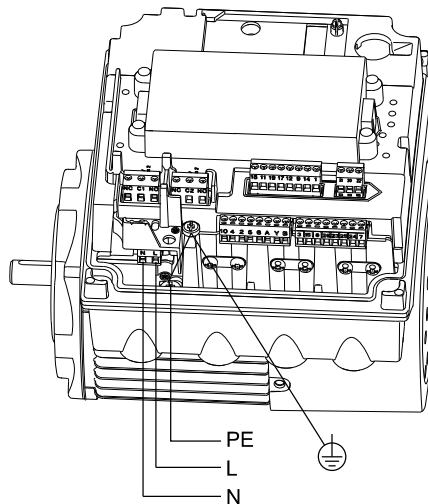

Fig. 7 Mains connection, 1 x 200-240 V models, single-phase motors

TM05 3494 1512

1 x 115 V models

Connect plug and line cord on the pump to 1 x 115 V outlet from the electricity supply

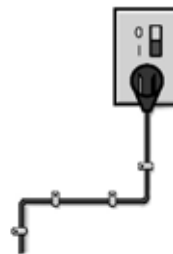

Fig. 8 Connect 1x 115 V models into 1 x 115 V outlet

TM06 3507 0115

Connecting 1 x 115 V models directly into a 1 x 115 V outlet is recommended. If extension cord is used, do not use wire smaller than 14 AWG.

Use of metal conduit with metal conduit connectors is recommended for all electrical connections.

6.2.2 Single-phase motors

If the motor is connected to an electric installation where an earth leakage circuit breaker (ELCB) or ground fault circuit interrupter (GFCI) is used as additional protection, this circuit breaker or interrupter must be marked with the following symbol:

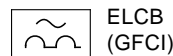

ELCB (GFCI)

Note

When an earth leakage circuit breaker or ground fault circuit interrupter is selected, the total leakage current of all the electrical equipment in the installation must be taken into account.

7. Operating conditions

7.1 Maximum number of starts and stops

The number of starts and stops via the power supply must not exceed four times per hour.

When switched on via the power supply, the pump will start after approx. 5 seconds.

If a higher number of starts and stops is desired, use the digital input for external start/stop when starting/stopping the pump.

When started via an external on/off digital input, the pump will start immediately.

7.2 Ambient temperature

7.2.1 Ambient temperature during storage and transportation

Minimum -22 °F (-30 °C)

Maximum 140 °F (+60 °C).

7.2.2 Ambient temperature during operation

Minimum -4 °F (-20 °C)

Maximum 113 °F (+45 °C) (115 V models).

Maximum 122 °F (+50 °C) (220 V models)

The motor can operate with the rated power output (P2) at 122 °F (50 °C), but continuous operation at higher temperatures will reduce the expected product life. If the motor is to operate at ambient temperatures between 122 °F and 140 °F (50 and 60 °C), an oversized motor must be selected. Contact Grundfos for further information.

7.3 Installation altitude

Caution

The motor must not be installed more than 6500 ft. (2000 meters) above sea level.

Installation altitude is the height above sea level of the installation site.

- Motors installed up to 3280 ft. (1000 meters) above sea level can be loaded 100 %.
- Motors installed more than 3280 ft. (1000 meters) above sea level must not be fully loaded due to the low density and consequent low cooling effect of the air. See fig. 9.

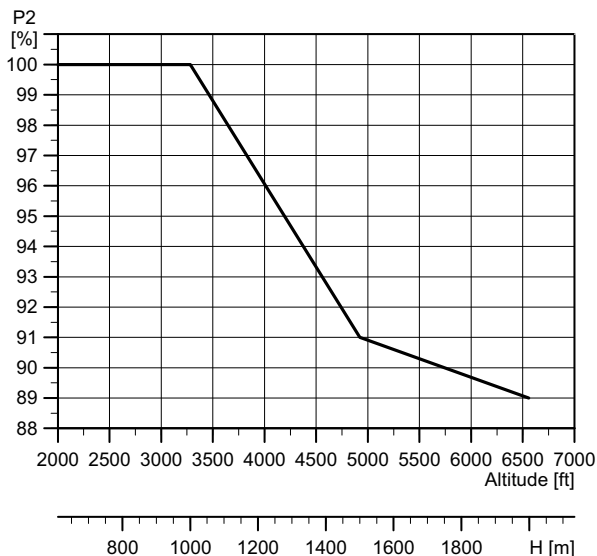

Fig. 9 Derating of motor output power (P2) in relation to altitude above sea level

7.4 Air humidity

Maximum air humidity: 95 %.

If the air humidity is constantly high and above 85 %, the drain holes in the drive-end flange should be open. See section [5.5 Drain holes](#).

7.5 Motor cooling

To ensure cooling of motor and electronics, the following must be observed:

- Position the motor in such a way that adequate cooling is ensured. See section [5.3 Ensuring motor cooling](#).
- The temperature of the cooling air must not exceed 50 °C (122 °F) for 1x230V or 45 °C (113 °F) for 1x115V CMBE pumps.
- Keep cooling fins and fan blades clean.

7.6 Pumps with factory-fitted pressure sensor

The pressure sensor is fitted on the pump discharge side, and the pump is set to constant pressure.

In this control mode, the pump will adjust its performance, i.e. pump discharge pressure, to the desired setpoint (H_{set}). See fig. 10.

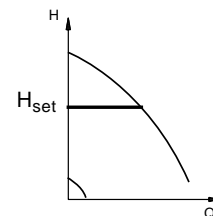

Fig. 10 Pump in constant-pressure control mode

8. Startup

After having carried out the mechanical and electrical installation described in sections previously, proceed as follows:

8.1 Positive inlet pressure start-up procedure

1. Check that the precharge pressure in the diaphragm tank is 0.7 times the required discharge pressure (setpoint).
2. Ensure all valves on discharge side and suction side of pump are in open position.
3. Turn tap on discharge side of pump on allowing water to pass through pump.
4. Turn power on to pump and press start/stop button on pump to turn pump on.
5. Adjust the required setpoint pressure by using the up or down arrows on motor.

8.2 Flooded suction and suction lift start up procedures

1. Check that the precharge pressure in the diaphragm tank is 0.7 times the required discharge pressure (setpoint).
2. Use 10 mm allen wrench to remove vent plug on front of pump just above suction port.
3. Use funnel and fill water into pump through vent port. When water is no longer able to fill into pump, the pump is primed.
4. Reinstall vent plug. Be careful not to cross thread vent plug while reinstalling.
5. Ensure all valves on discharge side and suction side of pump are in open position
6. Turn power on to pump and press start/stop button on pump to turn pump on.
7. 6. Adjust the required setpoint pressure by using the up or down arrows on motor.

9. User interfaces



Warning

The product may be so hot that only the buttons should be touched to avoid burns.

Pump settings can be made by means of the following user interfaces:

Control panel

- Standard control panel.
See section 9.1 Standard control panel.

9.1 Standard control panel

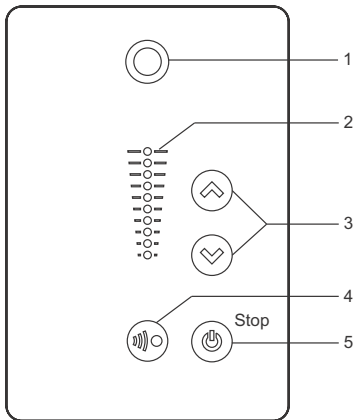

TM05 4848 3512

Fig. 11 Standard control panel

Pos.	Symbol	Description
1		Grundfos Eye Shows the operating status of the pump. See section 10. Grundfos Eye for further information.
2	-	Light fields for indication of setpoint.
3		Changes the setpoint.
4		Enables radio communication with the Grundfos GO Remote and other products of the same type. Makes the pump ready for operation/starts and stops the pump. Start: If the button is pressed when the pump is stopped, the pump will only start if no other functions with higher priority have been enabled.
5		Stop: If the button is pressed when the pump is running, the pump will always be stopped. When the pump is stopped via this button, the "Stop" text next to the button will illuminate.

9.1.1 Setpoint setting

Set the desired setpoint of the pump by pressing or . The light fields on the control panel will indicate the setpoint set.

Pump in constant-pressure control mode

The following example applies to a pump in an application where a pressure sensor gives a feedback to the pump. If the sensor is retrofitted to the pump, it must be set up manually as the pump does not automatically register a connected sensor.

Figure 12 shows that the light fields 5 and 6 are activated, indicating a desired setpoint of 72.5 psi (5 bar) with a sensor measuring range from 0 to 145 psi (0 to 10 bar). The setting range is equal to the sensor measuring range.

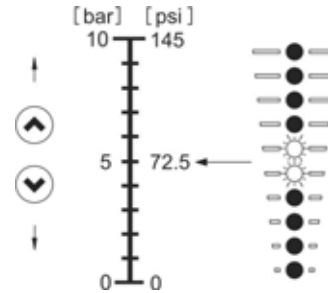

TM06 0692 0214

Fig. 12 Setpoint set to 72.5 psi (3 bar), constant-pressure control mode

9.1.2 Start/stop of pump

Stop the pump by pressing . When the pump is stopped, the "Stop" text next to the button will illuminate. The pump can also be stopped by continuously pressing until none of the light fields are on.

Start the pump by pressing or by continuously pressing until the desired setpoint is indicated.

If the pump has been stopped by pressing , it can only be given free to operation by pressing again.

If the pump has been stopped by pressing , it can only be restarted by pressing .

The pump can also be stopped with the R100, Grundfos GO Remote or via a digital input set to "External stop".

9.1.3 Resetting of alarms and warnings

A fault indication can be reset in one of the following ways:

- Via the digital input if it has been set to "Alarm resetting".
- Briefly press or on the pump. This will not change the setting of the pump.
A fault indication cannot be reset by pressing or if the buttons have been locked.
- Switch off the power supply until the indicator lights are off.
- Switch the external start/stop input off and then on again.
- With the R100/Grundfos GO Remote.

10. Grundfos Eye

The operating condition of the motor is indicated by the Grundfos Eye on the motor control panel. See fig. 13, pos. A.

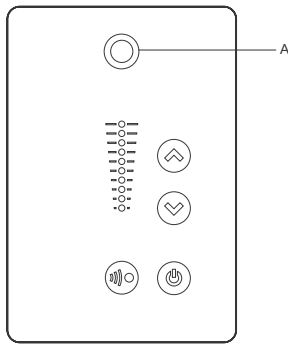

TM05 5993 4312

Fig. 13 Grundfos Eye

Grundfos Eye	Indication	Description
	No lights on.	Power off. Motor not running.
	Two opposite green indicator lights rotating in the direction of rotation of the motor when seen from the non-drive end.	Power on. Motor running.
	Two opposite green indicator lights permanently on.	Power on. Motor not running.
	One yellow indicator light rotating in the direction of rotation of the motor when seen from the non-drive end.	Warning. Motor running.
	One yellow indicator light permanently on.	Warning. Motor stopped.
	Two opposite red indicator lights flashing simultaneously.	Alarm. Motor stopped.
	The green indicator light in the middle flashes quickly four times.	Remote control with the Grundfos GO Remote via radio. The motor is trying to communicate with the Grundfos GO Remote. The motor in question is highlighted in the Grundfos GO Remote display to inform the user of the location of the motor.
	The green indicator light in the middle flashes continuously.	When the motor in question is selected in the Grundfos GO Remote menu, the green indicator light in the middle will flash continuously. Press on the motor control panel to allow remote control and data exchange via the Grundfos GO Remote.
	The green indicator light in the middle is permanently on.	Remote control with the Grundfos GO Remote via radio. The motor is communicating with the Grundfos GO Remote via radio connection.
	The green indicator light in the middle flashes quickly while the R100 or Grundfos Go Remote is exchanging data with the motor. It will take a few seconds.	Remote control with the R100 or Grundfos GO Remote via infrared light. The motor is receiving data from the R100 or Grundfos GO Remote via infrared communication.

Grundfos Kansas City
17100 West 118th Terrace
Olathe, Kansas 66061
Phone: (913) 227-3400
Fax: (913) 227-3500
www.grundfos.us

Grundfos Canada
2941 Brighton Road
Oakville, Ontario L6H 6C9 Canada
Phone: +1-905 829 9533
Telefax: +1-905 829 9512
www.grundfos.ca

Grundfos Mexico
Boulevard TLC No. 15
Parque Industrial Stiva Aeropuerto
C.P. 66600 Apodaca, N.L. Mexico
Phone: 011-52-81-8144 4000
Fax: 011-52-81-8144 4010
www.grundfos.mx

98636392 0615
ECM: 1160822

The name Grundfos, the Grundfos logo, and be think innovate are registered trademarks owned by Grundfos Holding A/S or Grundfos A/S, Denmark. All rights reserved worldwide. © Copyright Grundfos Holding A/S