

VLSE

Vertical in-line split coupled pumps with integrated VFD

Installation and operating instructions



Pump Information 3
Motor information 12

Original installation and operating instructions.

CONTENTS

1. Pump Information

2. Symbols used in this document	3
4. Installation - mechanical	4
4. Installation - mechanical	4
4.1 Pump identification	4
4.2 Receiving	4
4.3 Temporary storage	4
4.4 Location	5
4.5 Mounting of pump	5
4.6 Floor mounted pumps (VLSE)	5
4.7 Suspended pumps (VLSE)	5
4.8 Piping - general	5
4.9 Suction (inlet) piping	5
4.10 Discharge (outlet) piping	6
4.11 Shaft sealing - general comments	6
4.12 Mechanical seals	6
5. Installation-electrical	6
5.1 Motors general	6
6. Operation	7
6.1 Priming	7
6.2 Pre-start checklist	7
6.3 Motor rotation	7
6.4 Starting the pump	7
6.5 Voltage regulation	7
6.6 Pump shutdown	7
6.7 Short duration shutdown	7
6.8 Extended period shutdown	7
7. Maintenance	8
7.1 Motor lubrication	8
8. Disassembly	8
8.1 Preparation for disassembly	8
8.2 Seal replacement (VLSE)	8
8.3 Wear ring replacement	9
8.4 Reassembly of pumps	9
9. Ordering parts	9
10. Exploded views	10
10.1 Type VLSE, cross section and parts list	10
11. Troubleshooting	11
11.1 Cause codes	11
11.2 Possible causes	11

2. Symbols used in this document

The following symbols may be used in this document.



Warning
If these safety instructions are not observed, it may result in personal injury.



Warning
If these instructions are not observed, it may lead to electric shock with consequent risk of serious personal injury or death.



Warning
When pumping hazardous liquids, special attention must be paid to the risk of personal injury.



Warning
The surface of the product may be so hot that it may cause burns or personal injury.



Warning
The sound pressure level is so high that hearing protection must be used.



Caution
If these safety instructions are not observed, it may result in malfunction or damage to the equipment.



Note
Notes or instructions that make the job easier and ensure safe operation.

3. Limited warranty

Products manufactured in this manual by GRUNDFOS CBS INC. (Grundfos) are warranted to the original user only to be free of defects in material and workmanship for a period of 24 months from date of installation, but not more than 30 months from date of manufacture. Grundfos' liability under this warranty shall be limited to repairing or replacing at Grundfos' option, without charge, F.O.B. Grundfos' factory or authorized service station, any product of Grundfos' manufacture. Grundfos will not be liable for any costs of removal, installation, transportation, or any other charges which may arise in connection with a warranty claim.

Products which are sold but not manufactured by Grundfos are subject to the warranty provided by the manufacturer of said products and not by Grundfos' warranty. Grundfos will not be liable for damage or wear to products caused by abnormal operating conditions, accident, abuse, misuse, unauthorized alteration or repair, or if the product was not installed in accordance with Grundfos' printed installation and operating instructions. To obtain service under this warranty, the defective product must be returned to the distributor or dealer of Grundfos' products from which it was purchased together with proof of purchase and installation date, failure date, and supporting installation data. Unless otherwise provided, the distributor or dealer will contact Grundfos or an authorized service station for instructions. Any defective product to be returned to Grundfos or a service station must be sent freight prepaid; documentation supporting the warranty claim and/or a Return Material Authorization must be included if so instructed.

GRUNDFOS WILL NOT BE LIABLE FOR ANY INCIDENTAL OR CONSEQUENTIAL DAMAGES, LOSSES, OR EXPENSES ARISING FROM INSTALLATION, USE, OR ANY OTHER CAUSES. THERE ARE NO EXPRESS OR IMPLIED WARRANTIES, INCLUDING MERCHANTABILITY OR FITNESS FOR A PARTICULAR PURPOSE, WHICH EXTEND BEYOND THOSE WARRANTIES DESCRIBED OR REFERRED TO ABOVE.

Some jurisdictions do not allow the exclusion or limitation of incidental or consequential damages and some jurisdictions do not allow limit actions on how long implied warranties may last. Therefore, the above limitations or exclusions may not apply to you. This warranty gives you specific legal rights and you may also have other rights which vary from jurisdiction to jurisdiction.



Warning

Prior to installation, read these installation and operating instructions. Installation and operation must comply with local regulations and accepted codes of good practice.



Warning

The use of this product requires experience with and knowledge of the product. Persons with reduced physical, sensory or mental capabilities must not use this product, unless they are under supervision or have been instructed in the use of the product by a person responsible for their safety. Children must not use or play with this product.

4. Installation - mechanical

Read these instructions thoroughly before installing and operating your Grundfos Type VLSE Vertical In-line Centrifugal Pump. Successful operation depends on careful attention to the procedures described in the first four Sections of this manual. Keep this instruction manual handy for future use.

4.1 Pump identification

All Grundfos Type VLSE pumps are identified by catalog and serial numbers. These numbers are stamped on the pump nameplate (fig. 1) affixed to each pump volute casing, and should be referred to in all correspondence with the Company.

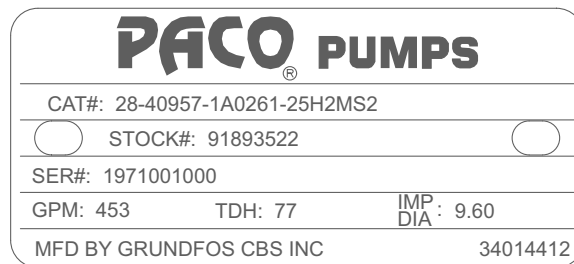

Fig. 1 Sample nameplate

4.2 Receiving

Check pumping unit for shortage and damage immediately upon arrival. Pump accessories when required are packaged in a separate container and shipped with the unit. If equipment is damaged in transit, promptly report this to the carrier's agent. Make complete notations on the freight bill to speed satisfactory adjustment by the carrier. Unload and handle the unit with a sling.



Do not lift pump assembly by motor eye bolts alone. Motor eye bolts are not designed to support weight of entire pump assembly.

4.3 Temporary storage

- If pump is not to be installed and operated soon after arrival, store it in a clean, dry area of moderate ambient temperature.
- Rotate the shaft by hand monthly to coat bearings with lubricant to retard oxidation and corrosion.
- Follow motor manufacturer's storage recommendations where applicable.
- During storage/transport maintain ambient temperature between -13 to 158 °F (-25 to +70 °C) for the E-motor. At low temperatures below the prescribed temperature the E-motor should be equipped with an anti-condensation heater. This could be an external heating element or an incorporated functionality of the E-motor. See specific sections for anti-condensation heater solutions.

4.4 Location

Locate the pump as close to the suction supply as possible. Use the shortest and most direct suction piping practical. Refer to section 4.9 *Suction (inlet) piping*. Locate the pump below system level wherever possible. This will facilitate priming, assure a steady liquid flow, and provide a positive suction head. Make sure sufficient NPSH (Net Positive Suction Head) is provided at the suction end by considering the pump's location in relation to the entire system. Available NPSH must always equal or exceed required NPSH specified on the pump performance curve. Always allow sufficient accessibility for maintenance and inspection. Provide a clear space with ample head room for use of a hoist strong enough to lift the pump/motor assembly. Make sure a suitable power source is available for the pump motor. Electrical characteristics should match those specified on the motor data plate, within the limits covered in sections 5. *Installation-electrical* and 6. *Operation*. Avoid pump exposure to sub-zero temperatures to prevent pump liquid from freezing. If freezing conditions exist during shutdown periods, see sections 6.7 *Short duration shutdown* and 6.8 *Extended period shutdown* for specific recommendations.

4.5 Mounting of pump

Grundfos Type VLSE In-line centrifugal pumps may be mounted on the equipment room floor, or suspended in the piping, depending on the size and configuration of the pump. The following instructions shall apply:

4.6 Floor mounted pumps (VLSE)

Pumps mounted on equipment room floors should be permanently installed on a firm, concrete foundation, mounting pad or spring isolation base of sufficient size to dampen any vibration and prevent any deflection. Suitable anchor bolts shall be used to secure the pump assembly to the pad or floor.

4.7 Suspended pumps (VLSE)

Pumps when properly supported, may be suspended in system piping. Pipe supports must be used on piping immediately adjacent to the pump. Pipe supports must be adequately sized to support the weight of pump and piping, full of liquid, and shall be designed to eliminate transmission of noise or vibration. Grundfos Type VLSE In line pumps are designed to be mounted in horizontal pipe runs with motor positioned vertically upward.

4.8 Piping - general

Caution

***Do not use pump as a support for piping!
Use pipe hangers or other supports at proper intervals to provide complete piping support near the pump.***

Both suction and discharge piping should be independently supported and properly aligned so that no strain is transmitted to the pump when flange bolts are tightened. Make sure piping is as straight as possible, avoiding unnecessary bends and fittings. Where necessary, use 45 ° or long-sweep 90 ° pipe fittings to decrease friction loss. Where flanged joints are used, make sure that inside diameters properly match and mounting holes are aligned. Do not spring or force piping when making any connections!

4.9 Suction (inlet) piping

The sizing and installation of suction piping is particularly important. It must be selected and installed in a manner that minimizes pressure loss and permits sufficient liquid flow into the pump during starting and operation. Many NPSH problems can be traced directly to improper design of suction piping systems. Observe the following precautions when installing suction piping: Suction piping should be as direct as possible, and ideally the length should be at least ten times the pipe diameter. Short suction piping can be the same diameter as the suction opening. Longer piping should be one or two sizes larger (depending on length), reducing to the diameter of the pump suction opening. Use an eccentric reducer, with the eccentric side down (fig. 2) when reducing the pipe diameter to the diameter of suction opening.

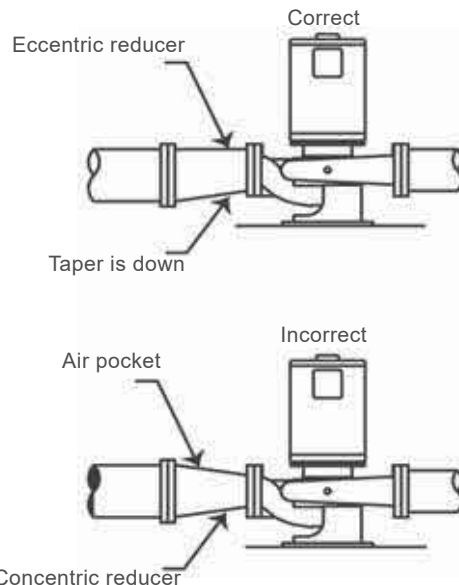

Fig. 2 Eccentric reducer usage

At no point should suction piping be smaller in diameter than the pump suction opening. Avoid any high points, such as pipe loops (fig. 3), that may create air pockets and throttle the system or produce erratic pumping.

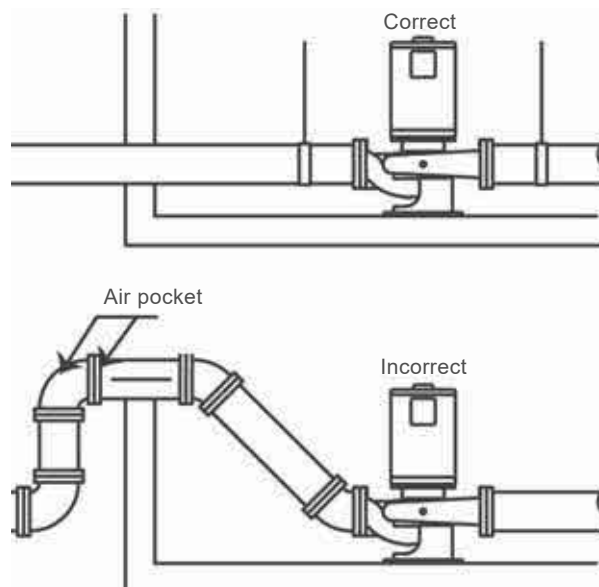

Fig. 3 Eccentric reducer usage

TM 05 4874 2612

TM05 4875 2612

Install a valve in the suction line to isolate the pump during shutdown and maintenance, and facilitate pump removal. Where two or more pumps are connected to the same suction line, install a valve for each pump to isolate pump from the line. Valves should always be installed in positions that avoid air pockets. Globe valves should not be used, particularly when NPSH is critical. During pumping operation, valves on suction line must always be at FULL OPEN. Properly sized pressure gauges can be installed in gauge taps on pump suction and discharge nozzles. Gauges enable the operator to monitor pump performance and determine that the pump conforms to the parameters of the performance curve. If cavitation, vapor binding, or other unstable operation occurs, pressure gauges will indicate wide fluctuation in suction and discharge pressures. Gauge cocks are recommended for use with pressure gauges, to protect gauges from constant wear and vibration when not in use.

4.10 Discharge (outlet) piping

Short discharge piping can be the same diameter as the pump discharge opening. Longer piping should be one or two sizes larger depending on length. An even gradient is best for long horizontal runs of discharge piping. Install a valve near the discharge opening to prime and start the pump. The discharge gate valve is also used to isolate the pump during shutdown, maintenance, and facilitate pump removal. Any high points in discharge piping may entrap air or gas and thus retard pump operation.

4.11 Shaft sealing - general comments

Grundfos Type VLSE pumps are equipped with mechanical shaft seals.

4.12 Mechanical seals

Grundfos mechanical seals are matched to conditions for which the pump was sold. Unlike packing, mechanical seals require no field adjustments. Observe the following precautions to avoid seal damage and obtain maximum seal life: Do not exceed temperature or pressure limitations for the mechanical seal used.

Caution

Do not run the pump dry or against a closed valve! Dry operation will cause seal failure within minutes.

Clean and purge suction piping in new installations before installing and operating pump. Pipe scale, welding slag and other abrasives can cause rapid seal failure.

5. Installation-electrical

5.1 Motors general

The motor control circuit must have the following components in order to comply with the National Electrical Code.

- **Motor Disconnecting Device:** A motor disconnecting device must be installed that is capable of disconnecting both the controller (motor starter) and the motor from their source of power.
- The disconnecting device must be located so that the controller (motor starter) can be seen from the disconnecting means. In all cases, the distance from the disconnecting device to the controller must be less than 50.
- In most installations the disconnecting device will be a circuit breaker or fusible disconnect switch.

Motor short circuit and ground fault protection:

- Short circuit and ground fault protection are usually provided by means of a circuit breaker or fusible disconnect switch.
- The selection of the size of the circuit breaker or fuse must be in accordance with Section 430-52 and Table 430-152 of the National Electrical Code.

Motor controller with running over current protection (magnetic starter):

- These components must be installed in accordance with applicable local and state electrical codes in addition to the National Electrical Code.



Warning

Whenever powered equipment is being used in explosive surroundings, the rules and regulations generally or specifically imposed by the relevant responsible authorities or trade organizations must be observed.

6. Operation

6.1 Priming

- The Grundfos Type VLSE in-line centrifugal pumps are not self priming, and must be completely primed (filled with liquid) before starting.
- If the pump will operate with a positive suction head, prime by opening the suction valve and allowing liquid to enter pump casing.
- Open all air vents at the high points of pump and piping to ensure air is forced from pump by liquid.
- Disconnect the recirculation line at the seal housing and bleed completely of all air.
- Re-connect the line prior to start-up.
- Rotate the shaft by hand to free entrapped air from impeller passageways.
- If pump has a suction lift, priming must be accomplished by other methods.
- The use of foot valves or ejectors, or manual filling of the pump casing and suction line with liquid are possible methods suggested for this purpose.

Caution

Never run the pump dry in the hope that it will prime itself! Serious damage to the mechanical seal will result.

6.2 Pre-start checklist

Warning



In the interest of operator safety, the unit must not be operated above the nameplate conditions. Such operation could result in unit failure causing injury to operating personnel. Consult instruction book for proper operation and maintenance of the pump and its supporting components.

Make the following inspections before starting your Grundfos Type VLSE pump:

1. Make sure all wiring connections to the motor (and starting device) match the wiring diagram and produce **clockwise** rotation as viewed from the end of the motor.
2. If the motor has been in storage for an extended length of time, either before or after installation, refer to motor instructions before starting.
3. Check voltage, phase, and line circuit frequency with the motor data plate.
4. Turn rotating element by hand to make sure it rotates freely.
5. Tighten plugs in gauge and drain taps. If pump is fitted with pressure gauges, keep gauge cocks closed when not in use.
6. Check suction and discharge piping for leaks, and make sure all flange bolts are securely tightened.

6.3 Motor rotation

Caution

Verify driver rotation prior to startup and operation. Failure to do so can result in serious damage to pump and driver if rotation is wrong.

6.4 Starting the pump

1. Install coupling guard on split coupled units.
2. Fully open gate valve (if any) in suction line, and close gate valve in discharge line.
3. Fill suction line with liquid and completely prime pump.
4. Start the motor (pump).
5. Immediately make a visual check of pump and suction piping for pressure leaks.
6. Immediately after pump reaches full operating speed, slowly open the discharge gate valve until complete system flow is achieved.
7. Check discharge piping for pressure leaks.
8. If pump is fitted with pressure gauges, open gauge cocks and record pressure reading for future reference. Verify that the pump is performing in accordance with parameters specified on performance curve.
9. Check and record voltage, amperage per phase, and kilowatts, if a wattmeter is available.

6.5 Voltage regulation

The motor will operate satisfactorily under the following conditions for voltage and frequency variation, but not necessarily in accordance with the standards established for operation under rated conditions: The voltage variation may not exceed 10 % above or below rating specified on the motor data plate. The frequency variation may not exceed 5 % above or below motor rating. The sum of the voltage and frequency variations may not exceed 10 % above or below motor rating, provided the frequency variation does not exceed 5 %.

6.6 Pump shutdown

The following shutdown procedures will apply in most normal shutdowns for Grundfos Type VLSE pump. If pump will be inoperative for an extended length of time, follow storage procedures in Section IC. Always close the discharge gate valve before stopping pump. Close valve slowly to prevent hydraulic shock. Cut power to motor.

6.7 Short duration shutdown

For overnight or temporary shutdown periods under nonfreezing conditions, the pump may remain filled with liquid. Make sure the pump is fully primed before restarting. For short or frequent shutdown periods under freezing conditions, keep fluid moving within pump casing and insulate or heat pump exterior to prevent freezing.

6.8 Extended period shutdown

For long shutdown periods, or to isolate the pump for maintenance, lock-out power to pump and close suction gate valve. If no suction valve is used and the pump has positive suction head, drain all liquid from suction line to terminate liquid flow into pump suction nozzle. Remove plugs in pump drain and vent taps, as required, and drain all liquid from the pump volute casing. If freezing conditions will exist during long shutdown periods, completely drain the pump and blow out all liquid passages and pockets with compressed air. Freezing of pump liquid can also be prevented by filling the pump with antifreeze solution.

7. Maintenance



Warning

Do not attempt any maintenance, inspection, repair or cleaning in the vicinity of rotating equipment. Before attempting any inspection or repair on the pump, the driver controls must be in the "OFF" position, locked and tagged to prevent injury to personnel performing service on the pump. Inspection, maintenance and repair should be performed by trained, qualified personnel only.

7.1 Motor lubrication

Always follow motor manufacturer's lubrication instructions if available, and periodically check grease fittings and drain plugs for leaks. Use the standard lubrication interval, see installation and operating instructions or the lubrication plate on the E-motor. If lubricating instructions do not accompany motor, refer to for recommended lubrication periods.

Motor RPM	Motor HP	Operating conditions		
		Standard	Severe	Extreme
1750	0.33 - 7.50	3 yrs	1 yr	6 mo
	10 - 40	1 - 3 yrs	6 mo - 1 yr	3 mo
	50 - 150	1 yr	6 mo	3 mo
	200 and up	1 yr	6 mo	3 mo
above 1750	all hp	6 mo	3 mo	3 mo

Standard conditions:

8 hours per day operation, normal or light loading, clean air, 100 °F, maximum ambient temperature.

Severe conditions:

Continuous 24-hour operation, shock loading or vibration, poor ventilation, 100-150 °F, ambient temperature.

Extreme conditions:

Continuous operation, heavy shock or vibration, dirt or dust in air, extreme ambient temperature.

8. Disassembly

8.1 Preparation for disassembly



Warning

Turn off power, lock-out electrical breaker and provide appropriate "Do Not Operate" or equivalent signage prior to any work on equipment. Verify all power is off at pump using appropriate electrical instrumentation. Work should be performed only by qualified and trained personnel.

Complete disassembly instructions are outlined below. Proceed only as far as required to perform the maintenance work needed. Close valves on suction and discharge side of pumps and drain pump, taking precautions as necessary based on fluid being pumped. Flush, if necessary. Allow adequate working area around pump for maintenance or disassembly.

8.2 Seal replacement (VLSE)

1. Complete preparations noted.
2. Remove coupling guard (34F).
3. Remove coupling bolts (8E). Pry apart the coupling halves (23D), remove keys (12B) and set aside.

Note

Mark or measure the original position of the pump coupling on the motor side.

4. Unscrew tubing connector from pipe tee of air vent assembly. Pipe dope is applied to threads during factory assembly, and resulting bond may retard but will not prevent manual disassembly.
5. Remove seal cap bolts and slide seal cap (2N) up shaft to remove.
6. Remove seal head assembly manually from shaft (6A). Water-soluble lubricant may be applied to shaft to ease removal of shaft seal (14A). Pull seal head assembly manually from shaft, using slight twisting motion (as necessary) to loosen bellows from shaft.
7. Remove and discard seal spring and retainer.
8. remove and discard seal seat from seal cap (2N) and thoroughly clean the inside cavity of seal cap.
9. Interior surface of bellows on new seal head is coated with bonding agent that adheres to motor shaft. When old seal head is removed, bonding agent no longer exists and bellows may crack or split during removal. Installation of new mechanical seal is always recommended if it becomes necessary to remove existing seal from shaft.
10. Clean and lubricate shaft (6A) with water-soluble lubricant and make sure no sharp edges exist to cut or scratch bellows of new seal.
11. Press new seal seat firmly into seal cap. Avoid direct contact of seal face with metallic or abrasive objects and wipe clean after installation to ensure abrasive free sealing surface.
12. Slide new seal head assembly onto shaft by applying even pressure to base of assembly.
13. Install seal cap (2N) down shaft.
14. See reassembly instructions.

8.3 Wear ring replacement

1. Complete preparations
2. Back-pull rotating assembly,
3. It may be necessary to remove volute (1A) from piping, to facilitate easy access to interior of volute. If necessary, remove flange bolts at piping.
4. To remove worn Case Wear Ring (4A), drill two holes slightly smaller than width of ring into exposed edge of ring. Once holes are drilled, a chisel may be used to completely sever ring at holes and break ring into two halves for easy removal.
5. Clean the ring cavity in the volute prior to installing wear ring to ensure a properly aligned fit.
6. To reassemble, press fit new wear ring squarely into volute casing cavity. Ring may be tapped into place to make sure it is completely impressed into cavity.

Caution

Do not use metal tooling against wear ring surfaces. Use only rubber, rawhide, wood or other soft material to prevent damage to ring.

8.4 Reassembly of pumps

1. Clean all parts prior to reassembly, ensuring all contacting surfaces and threads are free of debris. Reassemble pump by following the above instructions in reverse. Inspect and ensure the following:
 - All mechanical seal components and shaft sleeve must be in good condition or leakage may result.
 - Replacement of complete seal assembly is recommended.
 - Appropriate Loctite is used in re-assembly of shaft sleeves.
 - Appropriate Loctite is used in re-assembly of threaded impellers.
2. Re-install coupling guards on coupled pumps.



Warning

Type VLSE pump is a split coupled pump. Coupling guard must be reinstalled and in place prior to operation.

9. Ordering parts

Grundfos commitment to state-of-the-art pump design and quality manufacturing assures maximum user benefits with optimum equipment life at lower cost. Grundfos commitment to their customers continues through an extensive service organization. Highly trained technicians can assist customers with initial startup, troubleshooting, repair, and system analysis.

Grundfos maintains an extensive stock of replacement parts and parts kits for our most popular model pumps. Shipment of these parts is normally made within three days after receipt of an order. On larger pumps, where it is impractical for our factory to inventory low usage parts, replacement parts are normally manufactured and shipped within 15 working days of receipt of an order. In order to reduce pump repair time and shorten inconvenient pump service interruptions, it is suggested that the pump user stock spare parts. Since spare parts requirements and quantities vary for specific pump constructions, allow your Grundfos Representative to help in defining your spare part requirements. To ensure that the proper replacement parts are ordered for your particular pump model, when you call: Identify all pertinent data from the pump name plate (see Pump Identification). This should always include the pump Catalog or Model Number, and the pump Serial Number. For replacement impellers, also include from the nameplate the operating conditions (GPM and TDH) and the impeller diameter. Identify all parts by item number and description as indicated by the appropriate assembly drawing in this manual, for your particular pump model.

10. Exploded views

10.1 Type VLSE, cross section and parts list

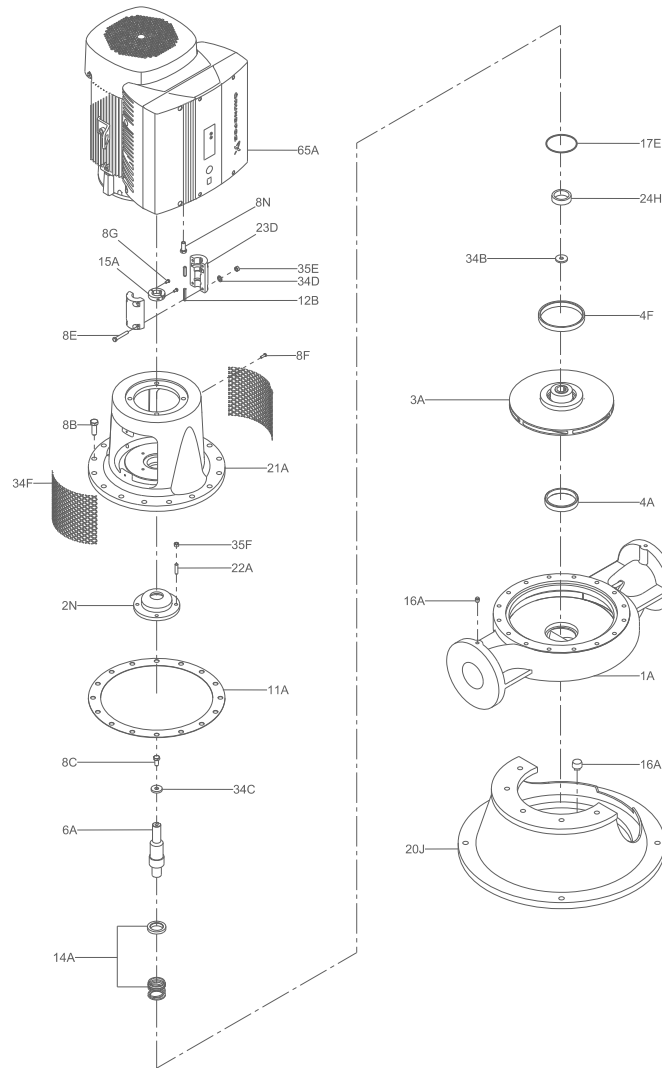

TM06 1657 2614

Pos.	Description
1A	Volute
2N	Seal cap
3A*	Impeller
4A*	Case wear ring
4F	Balance ring
6A	Pump shaft
8B	Volute screw
8C	Pump shaft screw
8E	Coupling screw
8F	Coupling guard screw
8G	Locating ring screw
8N	Motor screw
11A*	Volute gasket
12B	Coupling key
14A*	Seal assembly

* Recommended spare parts

Pos.	Description
15A	Locating ring
16A	Pipe plug
17E	Seal cap o-ring
20J	Cast iron stand
21A	Motor bracket
22A	Seal cap studs
23D	Coupling halves
24H	Bushing
34B*	Impeller washer
34C	Pump shaft washer
34D	Coupling Washer
34F	Coupling guard
35E	Coupling Nut
35F	Seal cap nut
65A	Motor

11. Troubleshooting

11.1 Cause codes

Symptoms	Cause code
Pump does not deliver any liquid at start-up	1*2*3*4*5*6*7*8*9*10*11*14*16*17*22*23*24*34
Pump stops delivering liquid after start-up	2*3*4*5*6*7*8*9*10*11*12*13*22*23*24*34
Pump overheats and/or ceases to deliver liquid	1*3*9*10*11*21*22*27*29*30*31*33*34*40*41
Insufficient flow rate	2*3*4*5*6*7*8*9*10*11*14*16*17*20*21*22*23*24*25*26*34
Excessive flow rate	15*18*20*34
Discharge pressure is too high	4*14*16*18*20*22*23*24*25*26*34
Shaft seal leaks appreciably, or the packing leaks excessively	27*28*29*30*33*34*35*36*39
Shaft seal or packing fails prematurely	12*13*27*28*29*30*33*34*35*36*37*38*39
Pump uses too much power	15*16*18*19*20*23*25*27*28*31*33*34*35*37*38
Pump runs rough and noisily	2*3*4*5*6*7*8*9*10*11*15*17*18*21*23*24*27*28*29*30*31*32*33*34*40

11.2 Possible causes

- The pump has not been properly bled of air.
- The pump suction line has not been completely primed.
- The suction head (NPSHR) required by the pump is too high, or the net positive suction head available (NPSHA) at your facility is too low.
- The fluid pumped contains too much entrained air or gas.
- There are air pockets in the suction line.
- An entry of air has suddenly occurred in the suction line.
- An entry of air past the shaft seal into the pump has occurred.
- The inlet of the suction line is insufficiently submerged.
- The suction valve is closed or only partially open.
- The suction strainer is clogged with dirt or debris.
- The foot valve is clogged or undersized.
- Little or no cooling fluid supplied to the shaft seals.
- The lantern ring is not positioned opposite the flushing inlet thereby restricting fluid flow.
- Pump drive rotational speed too low.
- Pump drive rotational speed too high.
- Pump rotation wrong or impeller installed backwards.
- Total head of installation (back pressure) higher than rated total head of the pump.
- Total head of installation (back pressure) lower than rated total head of the pump.
- Density of fluid pumped differs from that specified when the pump was purchased.
- Viscosity of fluid pumped differs from that specified when the pump was purchased.
- The pump is operating at too low a rate of flow. The discharge valve may be throttled too much.
- If pumps are operating in parallel, the pump characteristics may not be suitable for parallel operation.
- The impeller may be clogged with debris.
- The impeller may be damaged.
- The casing and impeller wear rings may be excessively worn.
- There may be internal leakage from the discharge to the suction compartments as the result of internal gasket failure.
- There may be a misalignment of the pump shaft.
- The shaft may chatter because it is bent.
- The pump may run rough due to improper balancing of the impeller.
- The shaft may not be running due to worn bearings.
- The impeller may be rubbing against the inside of the case.
- The concrete pad might not be of sufficient size to provide pump stability.
- The pump may have become misaligned during installation.
- The operating conditions of the installation do not agree with the data specified when the pump was purchased.
- The shaft seal may be incorrectly installed, or the stuffing box has not been packed correctly.
- The shaft sleeve may be scored or pitted in the region of the packing due to dirt or abrasive matter in the flushing fluid.
- Excessive tightening of the packing gland may block the flushing port thereby diminishing the sealing fluid flow.
- Packing material may have become wedged or extruded between the shaft and the bottom of the stuffing housing due to excessive clearance on the packing backup washer.
- The mechanical seal may have been damaged by running dry.
- There may be excessive axial thrust (side loading) due to improper impeller central alignment.

12. Motor information

13. General description	12
13.1 Pumps without factory-fitted sensor	12
13.2 Pumps with pressure sensor	12
13.3 Settings	12
14. Mechanical installation	13
14.1 Motor cooling	13
14.2 Outdoor installation	13
15. Electrical connection	13
15.1 Three-phase pumps, 3-10 hp	13
15.2 Three-phase pumps, 15-30 hp	15
15.3 Signal cables	17
15.4 E-pump electrical connections	17
15.5 Bus connection cable	19
16. Modes	19
16.1 Overview of modes	19
16.2 Operating mode	19
16.3 Control mode	20
17. Setting up the pump	20
17.1 Factory setting	20
18. Setting by means of control panel	20
18.1 Setting of operating mode	20
18.2 Setpoint setting	21
19. Setting by means of R100	21
19.1 Menu OPERATION	23
19.2 Menu STATUS	24
19.3 Menu INSTALLATION	25
19.4 Typical display settings for constant-pressure E-pumps	32
19.5 Typical display settings for analog-input E-pumps	33
19.6 Grundfos GO Remote	34
20. Setting by means of PC Tool E-products	35
21. Priority of settings	35
22. External forced-control signals	35
22.1 Start/stop input	35
22.2 Digital input	36
23. External setpoint signal	36
24. Bus signal	37
25. Other bus standards	37
26. Indicator lights and signal relay	37
27. Emergency operation (only 15-30 hp)	39
28. Insulation resistance	40
29. Maintenance and service	40
29.1 Cleaning of the motor	40
29.2 Relubrication of motor bearings	40
29.3 Replacement of motor bearings	40
29.4 Replacement of varistor (only 15-30 hp)	40
29.5 Service parts and service kits	40
30. Technical data - three-phase pumps, 3-10 hp	40
30.1 Supply voltage	40
30.2 Overload protection	40
30.3 Leakage current	40
30.4 Inputs/output	41
31. Technical data - three-phase pumps, 15-30 hp	41
31.1 Supply voltage	41
31.2 Overload protection	41
31.3 Leakage current	41
31.4 Inputs/output	41
31.5 Other technical data	42

32. Installation in the USA and Canada	43
32.1 Electrical connection	43
32.2 General considerations	43
33. Disposal	43

13. General description

Grundfos E-pumps have standard motors with integrated frequency converter. The pumps are for single-phase or three-phase power supply connection.

13.1 Pumps without factory-fitted sensor

The pumps have a built-in PI controller and can be set up for an external sensor enabling control of the following parameters:

- pressure
- differential pressure
- temperature
- differential temperature
- flow rate
- liquid level in a tank.

From factory, the pumps have been set to control mode uncontrolled. The PI controller can be activated by means of Grundfos GO and R100.

13.2 Pumps with pressure sensor

The pumps have a built-in PI controller and are set up with a pressure sensor enabling control of the pump discharge pressure.

The pumps are set to control mode controlled. The pumps are typically used to hold a constant pressure in variable-demand systems or differential pressure in closed-loop applications.

13.3 Settings

The description of settings apply both to pumps without factory-fitted sensor and to pumps with a factory-fitted pressure sensor.

Setpoint

The desired setpoint can be set in three different ways:

- directly on the pump control panel
- via an input for external setpoint signal
- by means of Grundfos GO or wireless remote control.

Other settings

All other settings can only be made by means of the Grundfos GO or R100.

Important parameters such as actual value of control parameter, power consumption, etc. can be read via the Grundfos GO or R100.

If special or customized settings are required, use Grundfos PC Tool E-products. Contact your local Grundfos company for more information.

14. Mechanical installation

The pump must be secured to a solid foundation by means of bolts through the holes in the flange or baseplate.

Note

In order to retain the UL/cUL approval, follow the additional installation procedures on page 43.

14.1 Motor cooling

To ensure sufficient cooling of motor and electronics, observe the following requirements:

- Make sure that sufficient cooling air is available.
- Keep the temperature of the cooling air below 104 °F (40 °C).
- Keep cooling fins and fan blades clean.

14.2 Outdoor installation

When installed outdoors, the pump must be provided with a suitable cover to avoid condensation on the electronic components. See fig. 4.

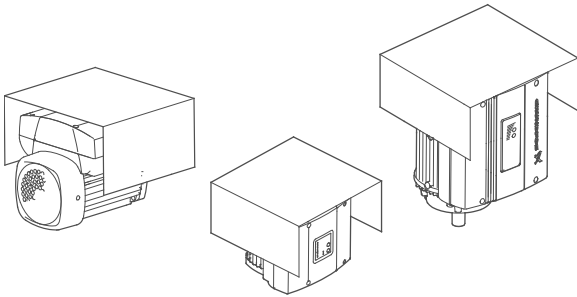

Fig. 4 Examples of covers

Remove the drain plug pointing downwards in order to avoid moisture and water build-up inside the motor.

Vertically mounted pumps are IP55 after removal of the drain plug. Horizontally mounted pumps change enclosure class to IP54.

15. Electrical connection

For description of how to connect E-pumps electrically, see the following pages:

15.1 Three-phase pumps, 3-10 hp, page 13

15.2 Three-phase pumps, 15-30 hp, page 15.

15.1 Three-phase pumps, 3-10 hp

Warning



The user or the installer is responsible for the installation of correct grounding and protection according to current national and local standards. All operations must be carried out by qualified personnel.

Warning



Never make any connections in the pump terminal box unless all electric supply circuits have been switched off for at least 5 minutes. Note for instance that the signal relay may be connected to an external supply which is still connected when the power supply is disconnected.

The above warning is indicated on the motor terminal box by this yellow label:



15.1.1 Preparation

Before connecting the E-pump to the power supply, take the issues illustrated in the figure below into consideration.

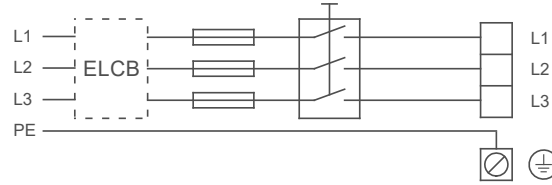

Fig. 5 Power supply-connected pump with power switch, backup fuses, additional protection and protective grounding

15.1.2 Protection against electric shock - indirect contact

Warning



The pump must be grounded in accordance with national regulations.

As the leakage current of 5-10 hp (4 - 7.5 kW) motors is > 3.5 mA, take extra precautions when grounding these motors.

EN 50178 and BS 7671 specify the following precautions when leakage current > 3.5 mA:

- The pump must be stationary and installed permanently.
- The pump must be permanently connected to the power supply.
- The grounding connection must be carried out as duplicate leads.

Protective ground leads must always have a yellow/green (PE) or yellow/green/blue (PEN) color marking.

15.1.3 Backup fuses

For recommended fuse sizes, see section 30.1 Supply voltage on page 41.

15.1.4 Additional protection

If the pump is connected to an electric installation where an ground leakage circuit breaker (ELCB) is used as additional protection, the circuit breaker must be of a type marked with the following symbols:



This circuit breaker is **type B**.

The total leakage current of all the electrical equipment in the installation must be taken into account.

The leakage current of the motor in normal operation can be seen in section 30.3 Leakage current on page 40.

During start and at asymmetrical supply systems, the leakage current can be higher than normal and may cause the ELCB to trip.

15.1.5 Motor protection

The pump requires no external motor protection. The motor incorporates thermal protection against slow overloading and blocking (IEC 34-11, TP 211).

15.1.6 Protection against voltage transients

The pump is protected against voltage transients by built-in varistors between the phases and between phases and ground.

TM00 8622 0101 - TM02 8514 0304

TM00 9270 4696

15.1.7 Supply voltage and power supply

3 x 440-480 V - 10 %/+ 10 %, 60 Hz, PE.

3 x 208-230 V - 10 %/+ 10 %, 60 Hz, PE.

The supply voltage and frequency are marked on the pump nameplate. Make sure that the pump is suitable for the power supply of the installation site.

The wires in the terminal box must be as short as possible. Excepted from this is the protective ground lead which must be so long that it is the last one to be disconnected in case the cable is inadvertently pulled out of the cable entry.

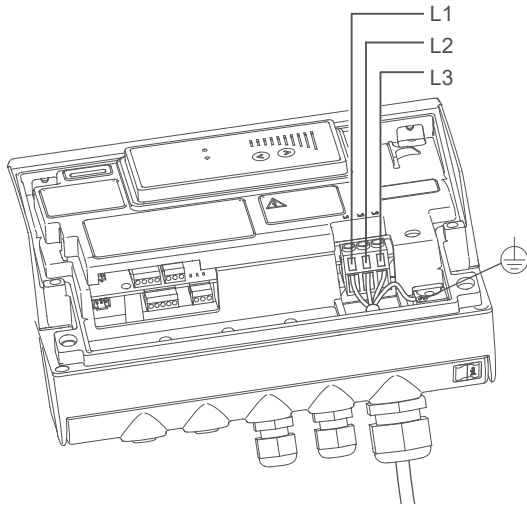

Fig. 6 Power connection

Cable glands

Cable glands comply with EN 50626.

- 2 x M16 cable gland
- 1 x M20 cable gland
- 2 x M16 knock-out cable entries.



Warning

If the supply cable is damaged, it must be replaced by qualified personnel.

Grid types

Three-phase E-pumps can be connected to all grid types.



Warning

Do not connect three-phase E-pumps to a power supply with a voltage between phase and ground of more than 440 V.

15.1.8 Start/stop of pump

Caution

The number of starts and stops via the power supply must not exceed 4 times per hour.

When the pump is switched on via the power supply, it will start after approx. 5 seconds.

If a higher number of starts and stops is desired, use the input for external start/stop when starting/stopping the pump.

When the pump is switched on via an external on/off switch, it will start immediately.

Automatic restart

Note

If a pump set up for automatic restart is stopped due to a fault, it will restart automatically when the fault has disappeared.

However, automatic restart only applies to fault types set up to automatic restart. These faults could typically be one of these faults:

- temporary overload
- fault in the power supply.

15.1.9 Connections

Note

If no external on/off switch is connected, connect terminals 2 and 3 using a short wire.

As a precaution, the wires to be connected to the following connection groups must be separated from each other by reinforced insulation in their entire lengths:

Group 1: Inputs

- start/stop terminals 2 and 3
- digital input terminals 1 and 9
- setpoint input terminals 4, 5 and 6
- sensor input terminals 7 and 8
- GENibus terminals B, Y and A

All inputs (group 1) are internally separated from the power-conducting parts by reinforced insulation and galvanically separated from other circuits.

All control terminals are supplied with protective extra-low voltage (PELV), thus ensuring protection against electric shock.

Group 2: Output (relay signal, terminals NC, C, NO)

The output (group 2) is galvanically separated from other circuits. Therefore, the supply voltage or protective extra-low voltage can be connected to the output as desired.

TMO3 8600 2007

15.1.10 Three-phase pumps, 3-10 hp

Group 3: Power supply (terminals L1, L2, L3)

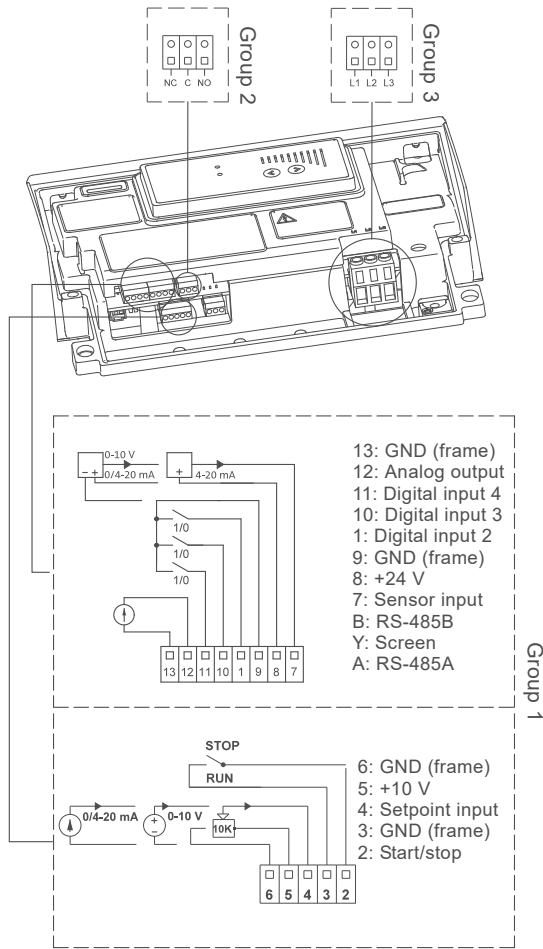

Fig. 7 Connection terminals

A galvanic separation must fulfill the requirements for reinforced insulation including creepage distances and clearances specified in EN 60335.

15.2 Three-phase pumps, 15-30 hp

Warning



The user or the installer is responsible for the installation of correct grounding and protection according to current national and local standards. All operations must be carried out by qualified personnel.

Warning



Never make any connections in the pump terminal box unless all electric supply circuits have been switched off for at least 5 minutes. Note for instance that the signal relay may be connected to an external supply which is still connected when the power supply is disconnected.

Warning



The surface of the terminal box may be above 158 °F (70 °C) when the pump is operating.

15.2.1 Preparation

Before connecting the E-pump to the power supply, take the issues illustrated in the figure below into consideration.

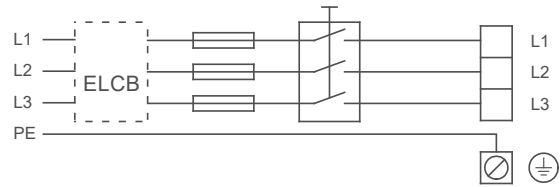

Fig. 8 Power supply-connected pump with power switch, backup fuses, additional protection and protective grounding

15.2.2 Protection against electric shock - indirect contact

Warning



The pump must be grounded in accordance with national regulations.

As the leakage current of 15-30 hp motors is > 10 mA, take extra precautions when grounding these motors.

EN 61800-5-1 specifies that the pump must be stationary and installed permanently when the leakage current is > 10 mA.

One of the following requirements must be fulfilled:

- A single protective ground lead (7 AWG minimum copper)

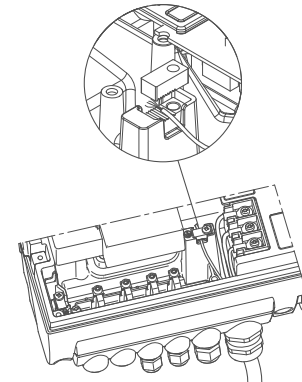

Fig. 9 Connection of a single protective ground lead using one of the leads of a 4-core power cable (7 AWG minimum)

- Two protective ground leads of the same cross-sectional area as the power supply leads, with one lead connected to an additional ground terminal in the terminal box.

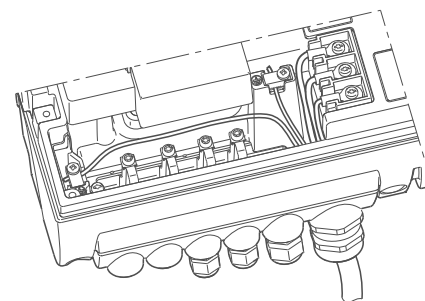

Fig. 10 Connection of two protective ground leads using two of the leads of a 5-core power supply cable

Protective ground leads must always have a yellow/green (PE) or yellow/green/blue (PEN) color marking.

TM00 9270 4696

TM05 2985 0812

TM04 3021 3508

TM03 8606 2007

15.2.3 Backup fuses

For recommended fuse sizes, see section 31.1 *Supply voltage* on page 41.

15.2.4 Additional protection

If the pump is connected to an electric installation where an ground leakage circuit breaker (ELCB) is used as additional protection, the circuit breaker must be of a type marked with the following symbols:



This circuit breaker is **type B**.

The total leakage current of all the electrical equipment in the installation must be taken into account.

The leakage current of the motor in normal operation can be seen in section 31.3 *Leakage current*.

During start and at asymmetrical supply systems, the leakage current can be higher than normal and may cause the ELCB to trip.

15.2.5 Motor protection

The pump requires no external motor protection. The motor incorporates thermal protection against slow overloading and blocking (IEC 34-11, TP 211).

15.2.6 Protection against voltage transients

The pump is protected against voltage transients in accordance with EN 61800-3 and is capable of withstanding a VDE 0160 pulse.

The pump has a replaceable varistor which is part of the transient protection.

Over time this varistor will be worn and need to be replaced. When the time for replacement has come, Grundfos GO, R100 and PC Tool E-products will indicate this as a warning. See section 29. *Maintenance and service* on page 40.

15.2.7 Supply voltage

3 x 440-480 V - 10 %/+ 10 %, 60 Hz, PE.

The supply voltage and frequency are marked on the pump nameplate. Make sure that the motor is suitable for the power supply of the installation site.

The wires in the terminal box must be as short as possible. Excepted from this is the protective ground lead which must be so long that it is the last one to be disconnected in case the cable is inadvertently pulled out of the cable entry.

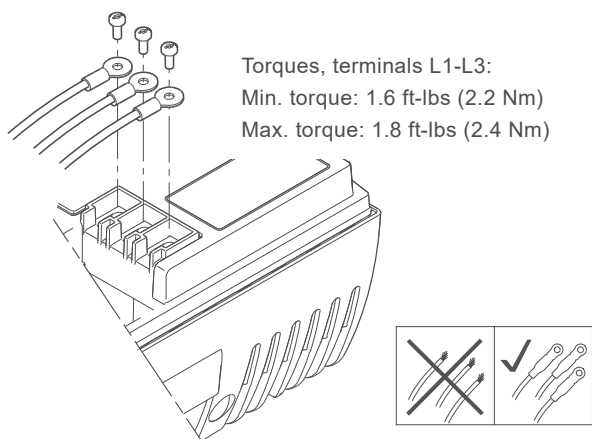

Fig. 11 Power connection

Cable glands

Cable glands comply with EN 50626.

- 1 x M40 cable gland
- 1 x M20 cable gland
- 2 x M16 cable gland
- 2 x M16 knock-out cable entries.



Warning

If the supply cable is damaged, it must be replaced by qualified personnel.

Grid types

Three-phase E-pumps can be connected to all grid types.



Warning

Do not connect three-phase E-pumps to a power supply with a voltage between phase and ground of more than 440 V.

15.2.8 Start/stop of pump

Caution

The number of starts and stops via the power supply must not exceed 4 times per hour.

When the pump is switched on via the power supply, it will start after approx. 5 seconds.

If a higher number of starts and stops is desired, use the input for external start/stop when starting/stopping the pump.

When the pump is switched on via an external on/off switch, it will start immediately.

15.2.9 Connections

Note

If no external on/off switch is connected, connect terminals 2 and 3 using a short wire.

As a precaution, the wires to be connected to the following connection groups must be separated from each other by reinforced insulation in their entire lengths:

Group 1: Inputs

- start/stop terminals 2 and 3
- digital input terminals 1 and 9
- setpoint input terminals 4, 5 and 6
- sensor input terminals 7 and 8
- GENibus terminals B, Y and A

All inputs (group 1) are internally separated from the power-conducting parts by reinforced insulation and galvanically separated from other circuits.

All control terminals are supplied with protective extra-low voltage (PELV), thus ensuring protection against electric shock.

Group 2: Output (relay signal, terminals NC, C, NO)

The output (group 2) is galvanically separated from other circuits. Therefore, the supply voltage or protective extra-low voltage can be connected to the output as desired.

Group 3: Power supply (terminals L1, L2, L3)

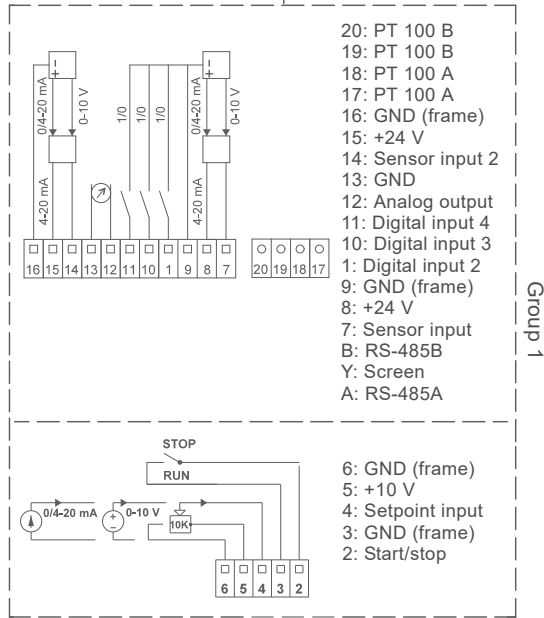
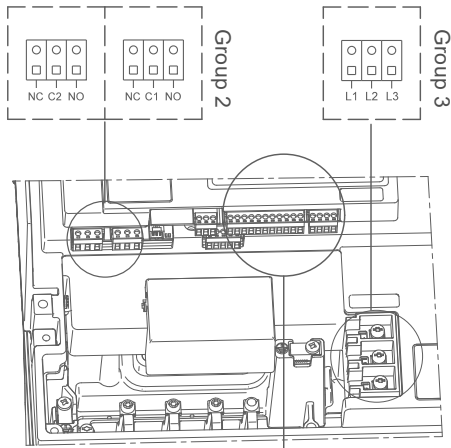

Fig. 12 Connection terminals

A galvanic separation must fulfill the requirements for reinforced insulation including creepage distances and clearances specified in EN 61800-5-1.

15.3 Signal cables

- Use screened cables with a conductor cross-section of min. 28 AWG and max. 16 AWG for external on/off switch, digital input, setpoint and sensor signals.
- Connect the screens of the cables to frame at both ends with good frame connection. The screens must be as close as possible to the terminals. See fig. 13.

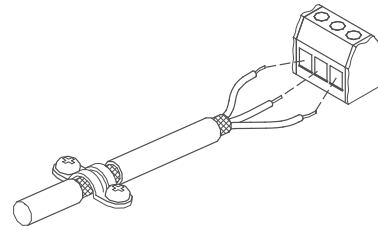

Fig. 13 Stripped cable with screen and wire connection

- Always tighten screws for frame connections whether a cable is fitted or not.
- Make the wires in the pump terminal box as short as possible.

15.4 E-pump electrical connections

15.4.1 Type key

	DPI	+T	0-6	G 1/2"	020	E,	Set
Type							
Temperature sensor:							
+T = with temperature Sensor							
Flow range [m ³ /h]							
Thread size							
Output signal:							
020 = 4-20 mA							
O-ring material:							
E = EPDM							
F = FKM							
Set = Complete pressure transmitter							

TM05 2986 0812

TM02 1325 0901

15.4.2 Electrical connections

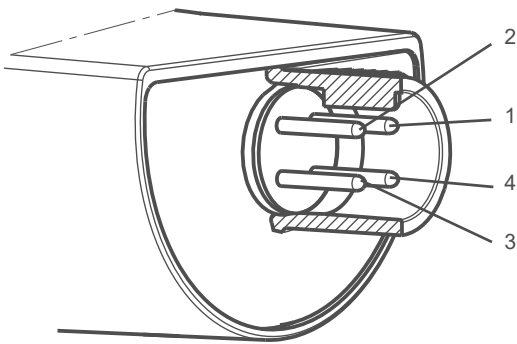

Fig. 14 Electrical connections

PIN	1	2	3	4
Wire color	Brown	Grey	Blue	Black
Output 4-20 mA	+	Not used	-	Not used
Output 2 x 0-10 V	+	Pressure signal	-*	Temperature signal

- * Common ground for both pressure and temperature signal.
- * Power supply (screened cable): SELV or PELV.
- * Grundfos will not be liable for damage or wear to products caused by abnormal operating conditions, accident abuse, misuse unauthorized alteration or repair, or if the product was not installed in accordance with Grundfos' printed installation and operating instructions. Splicing of the supplied cable would void any warranty.

TM04 7156 1610

15.4.3 Connection of E-pump to LiqTec®

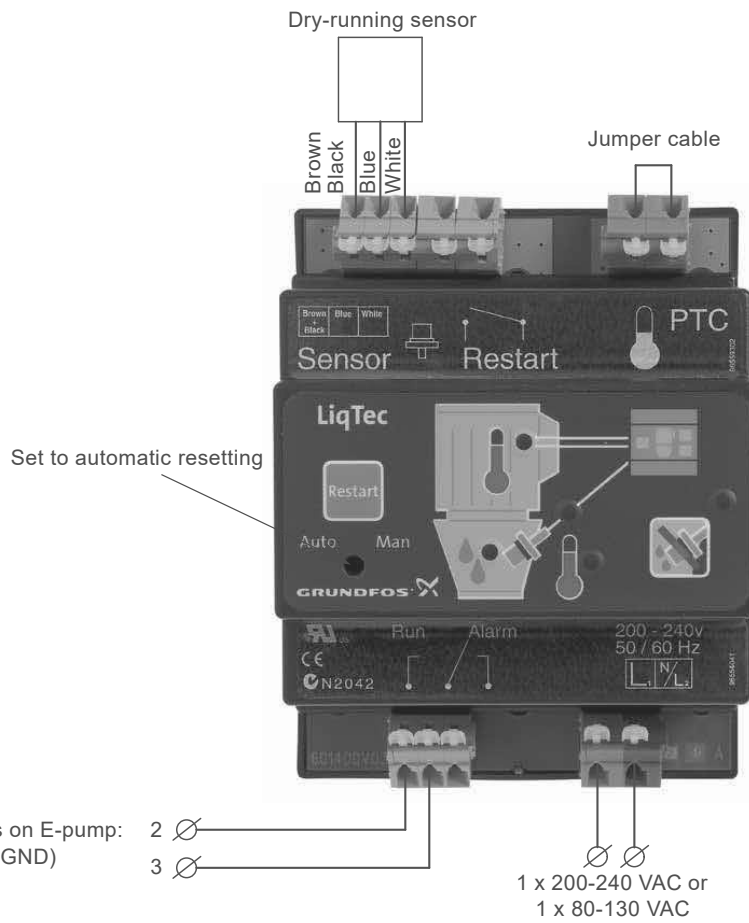

Fig. 15 Connection of E-pump to LiqTec

TM03 0437 5104

15.5 Bus connection cable

15.5.1 New installations

For the bus connection, use a screened 3-core cable with a conductor cross-section of 28-16 AWG.

- If the pump is connected to a unit with a cable clamp which is identical to the one on the pump, connect the screen to this cable clamp.
- If the unit has no cable clamp as shown in fig. 16, leave the screen unconnected at this end.

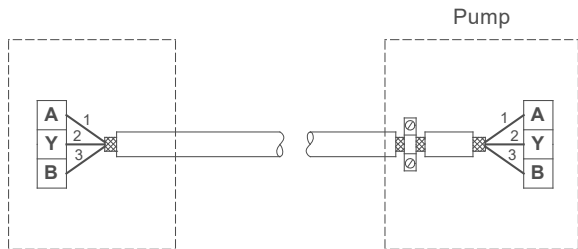

Fig. 16 Connection with screened 3-core cable

15.5.2 Replacing an existing pump

- If a screened 2-core cable is used in the existing installation, connect it as shown in fig. 17.

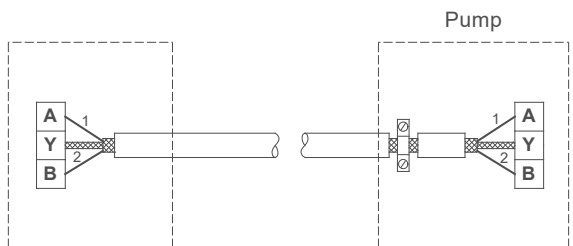

Fig. 17 Connection with screened 2-core cable

- If a screened 3-core cable is used in the existing installation, follow the instructions in section 15.5.1 *New installations* on page 19.

16. Modes

Grundfos E-pumps are set and controlled according to operating and control modes.

16.1 Overview of modes

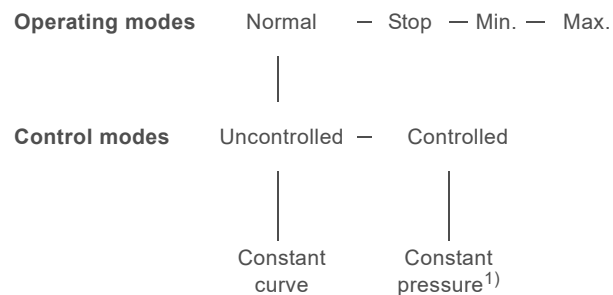

- ¹⁾ For this control mode the pump is equipped with a pressure sensor. The pump may also be equipped with a temperature sensor in which case the description would be constant temperature in control mode controlled.

16.2 Operating mode

When the operating mode is set to Normal, the control mode can be set to controlled or uncontrolled. See section 16.3 *Control mode* on page 20.

The other operating modes that can be selected are Stop, Min. or Max.

- Stop: the pump has been stopped
- Min.: the pump is operating at its minimum speed
- Max.: the pump is operating at its maximum speed.

Figure 18 is a schematic illustration of min. and max. curves.

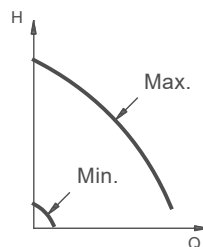

Fig. 18 Min. and max. curves

The max. curve can for instance be used in connection with the venting procedure during installation.

The min. curve can be used in periods in which a minimum flow is required.

If the power supply to the pump is disconnected, the mode setting will be stored.

The Grundfos GO and R100 offers additional possibilities of setting and status displays. See section 19. *Setting by means of R100* on page 21 and 33.

TM00 5547 0995

16.3 Control mode

16.3.1 Pumps without factory-fitted sensor

The pumps are factory-set to control mode **uncontrolled**.

In control mode **uncontrolled**, the pump will operate according to the constant curve set, fig. 19.

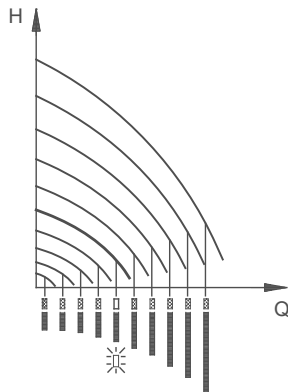

TM00 7746 1304

Fig. 19 Pump in control mode **uncontrolled** (constant curve)

16.3.2 Pumps with pressure sensor

The pump can be set to one of two control modes, i.e. controlled and uncontrolled, fig. 20.

In control mode **controlled**, the pump will adjust its performance, i.e. pump discharge pressure, to the desired setpoint for the control parameter.

In control mode **uncontrolled**, the pump will operate according to the constant curve set.

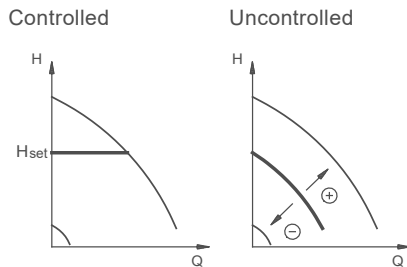

TM00 7668 0404

Fig. 20 Pump in control mode **controlled** (constant pressure) or **uncontrolled** (constant curve)

17. Setting up the pump

17.1 Factory setting

Pumps without factory-fitted sensor

The pumps have been factory-set to control mode **uncontrolled**. The setpoint value corresponds to 100 % of the maximum pump performance (see data sheet for the pump).

Pumps with pressure sensor

The pumps have been factory-set to control mode **controlled**. The setpoint value corresponds to 50 % of the sensor measuring range (see sensor nameplate).

18. Setting by means of control panel

Proportional pressure

The pump head is reduced at decreasing water demand and increased at rising water demand. See fig. 21.

This control mode is especially suitable in systems with relatively large pressure losses in the distribution pipes. The head of the pump will increase proportionally to the flow in the system to compensate for the large pressure losses in the distribution pipes.

The setpoint can be set with an accuracy of 0.33 ft (0.1 m).

The head against a closed valve is half the setpoint, $H_{set}/2$.

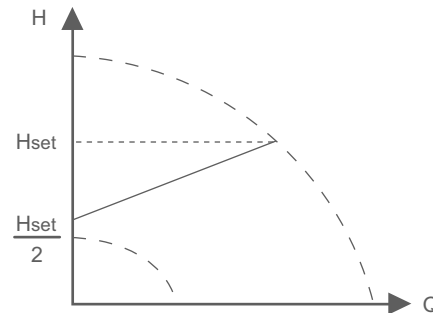

TM05 7909 1613

Fig. 21 Proportional pressure

This control mode requires a factory-fitted differential-pressure sensors as shown in the example below:

Example

- Factory-fitted differential-pressure sensor.

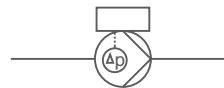

Fig. 22 Proportional pressure

18.1 Setting of operating mode

Settings available:

- Normal
- Stop
- Min.
- Max.

Start/stop of pump

Start the pump by continuously pressing ⊕ until the desired setpoint is indicated. This is operating mode Normal.

Stop the pump by continuously pressing ⊖ until none of the light fields are activated and the green indicator light flashes.

Setting to Min.

Press \downarrow continuously to change to the min. curve of the pump (bottom light field flashes). When the bottom light field is on, press \downarrow for 3 seconds until the light field starts flashing. To return to uncontrolled or controlled operation, press \uparrow continuously until the desired setpoint is indicated.

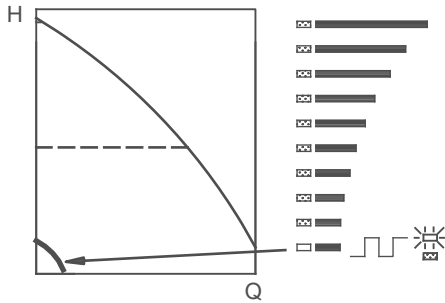

Fig. 23 Min. curve duty

Setting to Max.

Press \uparrow continuously to change to the max. curve of the pump (top light field flashes). When the top light field is on, press \uparrow for 3 seconds until the light field starts flashing. To return to uncontrolled or controlled operation, press \downarrow continuously until the desired setpoint is indicated.

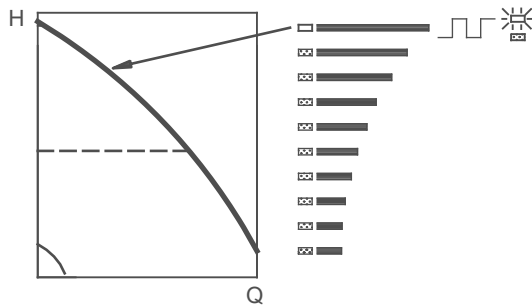

Fig. 24 Max. curve duty

18.2 Setpoint setting

Set the desired setpoint by pressing the button \uparrow or \downarrow . The light fields on the control panel will indicate the setpoint set. See examples in sections 18.2.1 Pump in control mode controlled (pressure control) on page 21 and 18.2.2 Pump in control mode uncontrolled on page 21.

18.2.1 Pump in control mode controlled (pressure control)

Example

Figure 25 shows that the light fields 5 and 6 are activated, indicating a desired setpoint of 43 psi (3 bar). The setting range is equal to the sensor measuring range (see sensor nameplate).

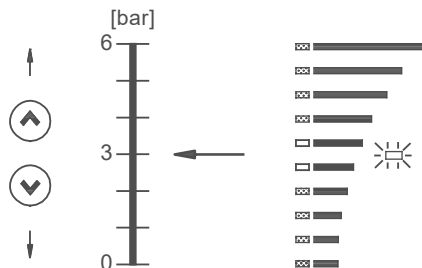

Fig. 25 Setpoint set to 3 bar, pressure control

18.2.2 Pump in control mode uncontrolled

Example

In control mode uncontrolled, the pump performance is set within the range from min. to max. curve. See fig. 26.

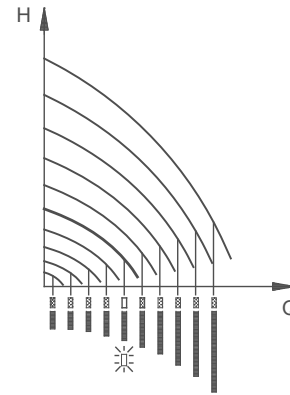

Fig. 26 Pump performance setting, control mode uncontrolled

19. Setting by means of R100

The pump is designed for wireless communication with Grundfos remote control R100.

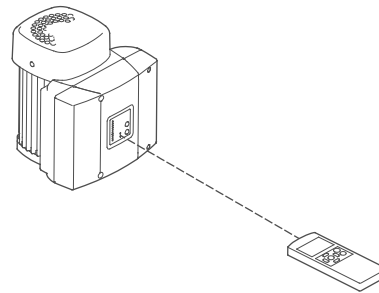

Fig. 27 R100 communicating with the pump via infra-red light

During communication, the R100 must be pointed at the control panel. When the R100 communicates with the pump, the red indicator light will flash rapidly. Keep pointing the R100 at the control panel until the red LED diode stops flashing.

- The R100 offers setting and status displays for the pump. The displays are divided into four parallel menus (see fig. 35):
- 0. GENERAL (see operating instructions for the R100)
 - 1. OPERATION
 - 2. STATUS
 - 3. INSTALLATION

The figure above each individual display in fig. 35 refers to the section in which the display is described.

TM00 7746 1304

TM00 7346 1304

TM00 7345 1304

TM02 0936 0501

TM00 7743 0904

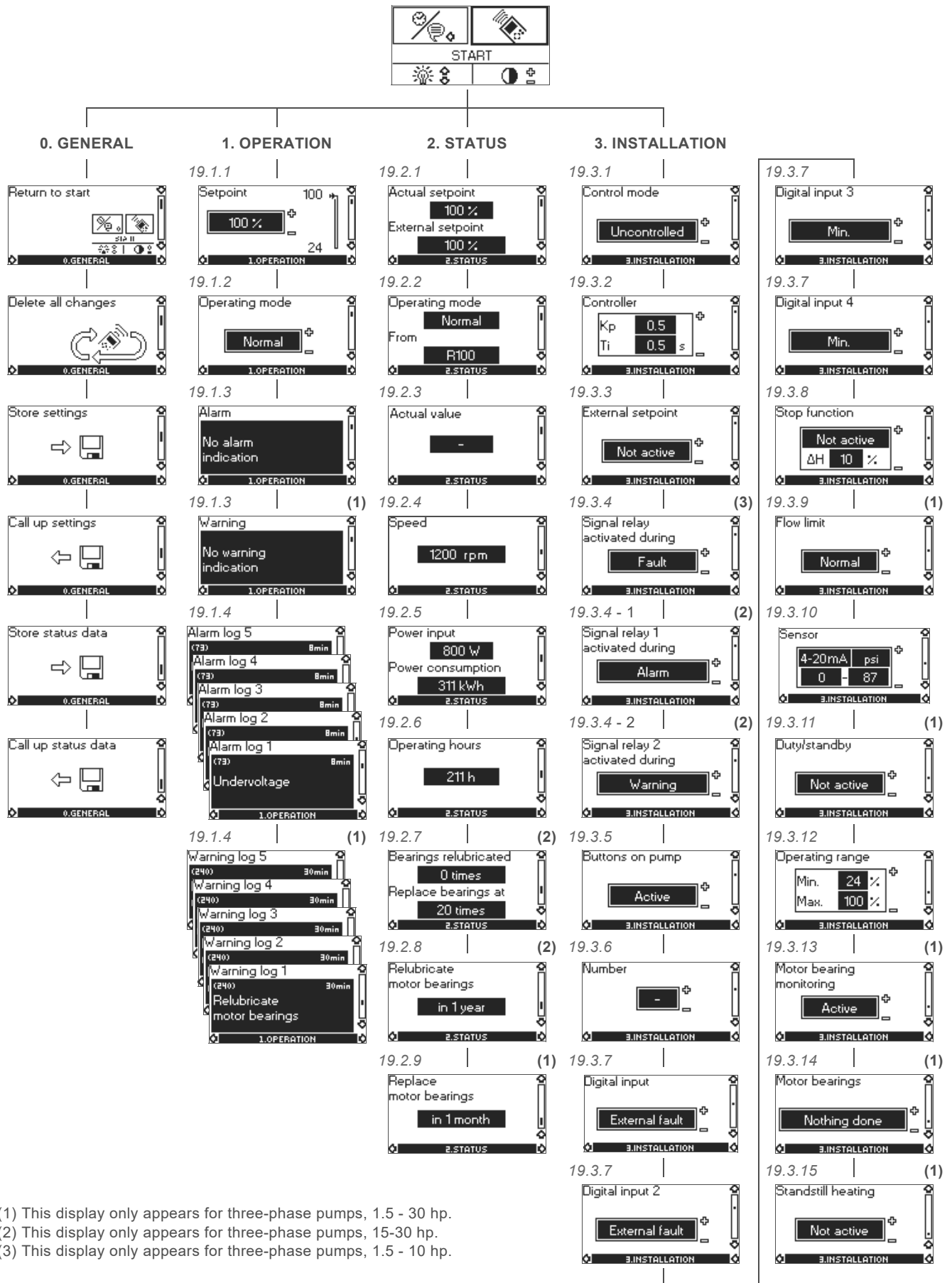

Displays in general

In the following explanation of the functions, one or two displays are shown.

One display

Pumps without or with factory-fitted sensor have the same function.

Two displays

Pumps without or with factory-fitted pressure sensor have different functions and factory settings.

19.1 Menu OPERATION

The first display in this menu is this:

19.1.1 Setpoint

Without sensor (uncontrolled)

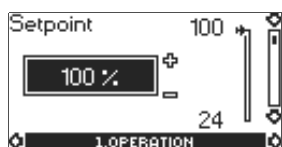

- ▶ Setpoint set
- ▶ Actual setpoint
- Actual value

Set the setpoint in %.

With pressure sensor (controlled)

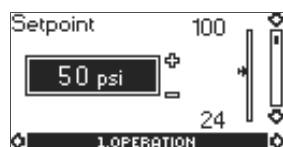

- ▶ Setpoint set
- ▶ Actual setpoint
- Actual value

Set the desired pressure in bar.

In control mode **uncontrolled**, the setpoint is set in % of the maximum performance. The setting range will lie between the min. and max. curves.

In control mode **controlled**, the setting range is equal to the sensor measuring range.

If the pump is connected to an external setpoint signal, the value in this display will be the maximum value of the external setpoint signal. See section 23. *External setpoint signal* on page 36.

Setpoint and external signal

The setpoint cannot be set if the pump is controlled via external signals (Stop, Min. curve or Max. curve). R100 will give this warning: External control!

Check if the pump is stopped via terminals 2-3 (open circuit) or set to min. or max. via terminals 1-3 (closed circuit).

See fig. 36 on page 33.

Setpoint and bus communication

The setpoint cannot be set either if the pump is controlled from an external control system via bus communication. R100 will give this warning: Bus control!

To override bus communication, disconnect the bus connection.

See fig. 36 on page 33.

19.1.2 Operating mode

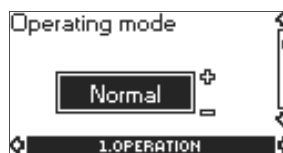

Set one of the following operating modes:

- Normal (duty)
- Stop
- Min.
- Max.

The operating modes can be set without changing the setpoint setting.

19.1.3 Fault indications

In E-pumps, faults may result in two types of indication: alarm or warning.

An "alarm" fault will activate an alarm indication in R100 and cause the pump to change operating mode, typically to stop. However, for some faults resulting in alarm, the pump is set to continue operating even if there is an alarm.

A "warning" fault will activate a warning indication in R100, but the pump will not change operating or control mode.

Note

The indication, Warning, only applies to three-phase pumps.

Alarm



In case of alarm, the cause will appear in this display.

Possible causes:

- No alarm indication
- Too high motor temperature
- Undervoltage
- Mains voltage asymmetry (15-30 hp)
- Overvoltage
- Too many restarts (after faults)
- Overload
- Underload
- Sensor signal outside signal range
- Setpoint signal outside signal range
- External fault
- Duty/standby, Communication fault
- Dry running
- Other fault.

If the pump has been set up to manual restart, an alarm indication can be reset in this display if the cause of the fault has disappeared.

Warning (only three-phase pumps)

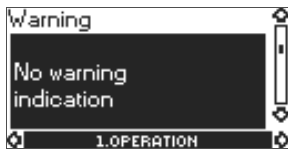

In case of warning, the cause will appear in this display.

Possible causes:

- No warning indication.
- Sensor signal outside signal range.
- Relubricate motor bearings, see section 29.2 *Relubrication of motor bearings* on page 40.
- Replace motor bearings, see section 29.3 *Replacement of motor bearings* on page 40.
- Replace varistor, see section 29.4 *Replacement of varistor (only 15-30 hp)* on page 40.

A warning indication will disappear automatically once the fault has been remedied.

19.1.4 Fault log

For both fault types, alarm and warning, the R100 has a log function.

Alarm log



In case of "alarm" faults, the last five alarm indications will appear in the alarm log. "Alarm log 1" shows the latest fault, "Alarm log 2" shows the latest fault but one, etc.

The example above gives this information:

- the alarm indication Undervoltage
- the fault code (73)
- the number of minutes the pump has been connected to the power supply after the fault occurred, 8 min.

Warning log



In case of "warning" faults, the last five warning indications will appear in the warning log. "Warning log 1" shows the latest fault, "Warning log 2" shows the latest fault but one, etc.

The example above gives this information:

- the warning indication Relubricate motor bearings
- the fault code (240)
- the number of minutes the pump has been connected to the power supply since the fault occurred, 30 min.

19.2 Menu STATUS

The displays appearing in this menu are status displays only. It is not possible to change or set values.

The displayed values are the values that applied when the last communication between the pump and the R100 took place. If a status value is to be updated, point the R100 at the control panel and press "OK". If a parameter, e.g. speed, should be called up continuously, press "OK" constantly during the period in which the parameter in question should be monitored.

The tolerance of the displayed value is stated under each display. The tolerances are stated as a guide in % of the maximum values of the parameters.

19.2.1 Actual setpoint

Without sensor
(uncontrolled)

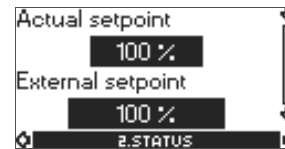

Tolerance: $\pm 2\%$.

With pressure sensor
(controlled)

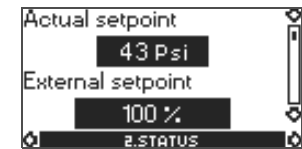

Tolerance: $\pm 2\%$.

This display shows the actual setpoint and the external setpoint in % of the range from minimum value to the setpoint set. See section 23. *External setpoint signal* on page 36.

19.2.2 Operating mode

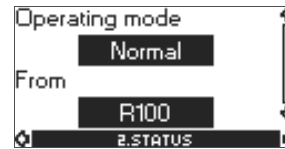

This display shows the actual operating mode (Normal (duty), Stop, Min., or Max.). Furthermore, it shows where this operating mode was selected (R100, Pump, Bus, External or Stop func.). For further details about the stop function (Stop func.), see section 19.3.8 *Stop function* on page 28.

19.2.3 Actual value

Without sensor
(uncontrolled)



With pressure sensor
(controlled)

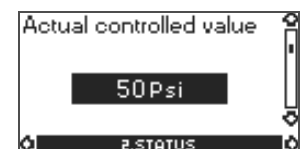

This display shows the value actually measured by a connected sensor.

If no sensor is connected to the pump, "-" will appear in the display.

19.2.4 Speed



Tolerance: $\pm 5\%$

The actual pump speed will appear in this display.

19.2.5 Power input and power consumption

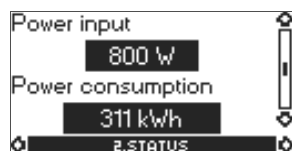

Tolerance: $\pm 10\%$

This display shows the actual pump input power from the power supply. The power is displayed in W or kW.

The pump power consumption can also be read from this display. The value of power consumption is an accumulated value calculated from the pump's birth and it cannot be reset.

19.2.6 Operating hours



Tolerance: $\pm 2\%$

The value of operating hours is an accumulated value and cannot be reset.

19.2.7 Lubrication status of motor bearings (only 15-30 hp)

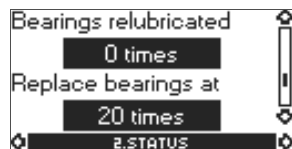

This display shows how many times the motor bearings have been relubricated and when to replace the motor bearings.

When the motor bearings have been relubricated, confirm this action in the INSTALLATION menu.

See section 19.3.14 *Confirming relubrication/replacement of motor bearings (only three-phase pumps)* on page 31.

When relubrication is confirmed, the figure in the above display will be increased by one.

19.2.8 Time till relubrication of motor bearings



This display shows when to relubricate the motor bearings. The controller monitors the operating pattern of the pump and calculates the period between bearing relubrications. If the operating pattern changes, the calculated time till relubrication may change as well.

The displayable values are these:

- in 2 years
- in 1 year
- in 6 months
- in 3 months
- in 1 month
- in 1 week
- Now!

19.2.9 Time till replacement of motor bearings

When the motor bearings have been relubricated a prescribed number of times stored in the controller, the display in section 19.2.8 *Time till relubrication of motor bearings* on page 25 will be replaced by the display below.



This display shows when to replace the motor bearings. The controller monitors the operating pattern of the pump and calculates the period between bearing replacements.

The displayable values are these:

- in 2 years
- in 1 year
- in 6 months
- in 3 months
- in 1 month
- in 1 week
- Now!

19.3 Menu INSTALLATION

19.3.1 Control mode

Without sensor
(uncontrolled)



Select one of the following control modes (see fig. 20):

- Controlled
- Uncontrolled.

With pressure sensor
(controlled)



Select one of the following control modes (see fig. 20):

- Controlled
- Uncontrolled.

Note

If the pump is connected to a bus, the control mode cannot be selected via the R100. See section 24. Bus signal.

19.3.2 Controller

E-pumps have a factory default setting of gain (K_p) and integral time (T_i). However, if the factory setting is not the optimum setting, the gain and the integral time can be changed in the display below.

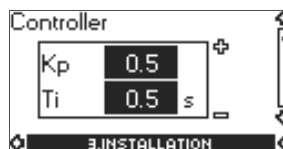

- The gain (K_p) can be set within the range from 0.1 to 20.
- The integral time (T_i) can be set within the range from 0.1 to 3600 s. If 3600 s is selected, the controller will function as a P controller.
- Furthermore, it is possible to set the controller to inverse control, meaning that if the setpoint is increased, the speed will be reduced. In the case of inverse control, the gain (K_p) must be set within the range from -0.1 to -20.

The table below shows the suggested controller settings:

System/application	K_p		T_i
	Heating systems*	Cooling systems**	
	0.5		0.5
	0.5		$L_1 < 16.4 \text{ ft: } 0.5$ $L_1 > 16.4 \text{ ft: } 3$ $L_1 > 32.8 \text{ ft: } 5$
	0.5		0.5
	0.5		0.5
	0.5	-0.5	$10 + 1.5L_2$
	0.5		$10 + 1.5L_2$
	0.5	-0.5	$30 + 1.5L_2$
	+2.5		100

- * Heating systems are systems in which an increase in pump performance will result in a **rise** in temperature at the sensor.
- ** Cooling systems are systems in which an increase in pump performance will result in a **drop** in temperature at the sensor.

L_1 = Distance in [ft] between pump and sensor

L_2 = Distance in [ft] between heat exchanger and sensor

How to set the PI controller

For most applications, the factory setting of the controller constants K_p and T_i will ensure optimum pump operation. However, in some applications an adjustment of the controller may be needed.

Proceed as follows:

1. Increase the gain (K_p) until the motor becomes unstable. Instability can be seen by observing if the measured value starts to fluctuate. Furthermore, instability is audible as the motor starts hunting up and down. Some systems, such as temperature controls, are slow-reacting, meaning that it may be several minutes before the motor becomes unstable.
2. Set the gain (K_p) to half of the value which made the motor unstable. This is the correct setting of the gain.
3. Reduce the integral time (T_i) until the motor becomes unstable.
4. Set the integral time (T_i) to twice the value which made the motor unstable. This is the correct setting of the integral time.

General rules of thumb:

- If the controller is too slow-reacting, increase K_p .
- If the controller is hunting or unstable, dampen the system by reducing K_p or increasing T_i .

19.3.3 External setpoint



The input for external setpoint signal can be set to different signal types.

Select one of the following types:

- 0-10 V
- 0-20 mA
- 4-20 mA
- Not active.

If Not active is selected, the setpoint set by means of the R100 or on the control panel will apply.

If one of the signal types is selected, the actual setpoint is influenced by the signal connected to the external setpoint input. See section 23. *External setpoint signal* on page 36.

19.3.4 Signal relay

Pumps of 3-10 hp have one signal relay. The factory setting of the relay will be Fault.

Pumps of 15-30 hp have two signal relays. Signal relay 1 is factory set to Alarm and signal relay 2 to Warning.

In one of the displays below, select in which one of three or six operating situations the signal relay should be activated.

3-10 hp



- Ready
- Fault
- Operation
- Pump running (only three-phase pumps, 3-10 hp)
- Warning (only three-phase pumps, 3-10 hp).

15-30 hp



- Ready
- Alarm
- Operation
- Pump running
- Warning
- Relubricate.

15-30 hp



- Ready
- Alarm
- Operation
- Pump running
- Warning
- Relubricate.

Fault and Alarm cover faults resulting in Alarm. Warning covers faults resulting in Warning.

Note

Relubricate covers only that one individual event. For distinction between alarm and warning, see section 19.1.3 Fault indications on page 23.

For further information, see section 26. *Indicator lights and signal relay* on page 37.

19.3.5 Buttons on pump



The operating buttons ☺ and ☹ on the control panel can be set to these values:

- Active
- Not active.

When set to Not active (locked), the buttons do not function.

Set the buttons to Not active if the pump should be controlled via an external control system.

19.3.6 Pump number



A number between 1 and 64 can be allocated to the pump. In the case of bus communication, a number must be allocated to each pump.

19.3.7 Digital inputs



The digital inputs of the pump can be set to different functions.

Select one of the following functions:

- Min. (min. curve)
- Max. (max. curve)
- External fault
- Flow switch
- Dry running (from external sensor) (only three-phase pumps).

The selected function is activated by closing the contact between terminals 1 and 9, 1 and 10 or 1 and 11.

See also section 22.2 *Digital input* on page 36.

Min.:

When the input is activated, the pump will operate according to the min. curve.

Max.:

When the input is activated, the pump will operate according to the max. curve.

External fault:

When the input is activated, a timer will be started. If the input is activated for more than 5 seconds, the pump will be stopped and a fault will be indicated. If the input is deactivated for more than 5 seconds, the fault condition will cease and the pump can only be restarted manually by resetting the fault indication.

Flow switch:

When this function is selected, the pump will be stopped when a connected flow switch detects low flow.

It is only possible to use this function if the pump is connected to a pressure sensor.

If the input is activated for more than 5 seconds, the stop function incorporated in the pump will take over. See section 19.3.8 *Stop function* on page 28.

Dry running:

When this function is selected, lack of inlet pressure or water shortage can be detected. This requires the use of an accessory, such as these:

- a Grundfos Liqtec® dry-running sensor
- a pressure switch installed on the suction side of a pump
- a float switch installed on the suction side of a pump.

When lack of inlet pressure or water shortage (Dry running) is detected, the pump will be stopped. The pump cannot restart as long as the input is activated.

19.3.8 Stop function

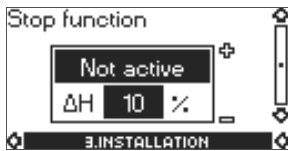

The stop function can be set to these values:

- Active
- Not active.

When the stop function is active, the pump will be stopped at very low flows. The controller will stop the pump to protect the pump as follows:

- avoid unnecessary heating of the pumped liquid
- reduce wear of the shaft seals
- reduce noise from operation.

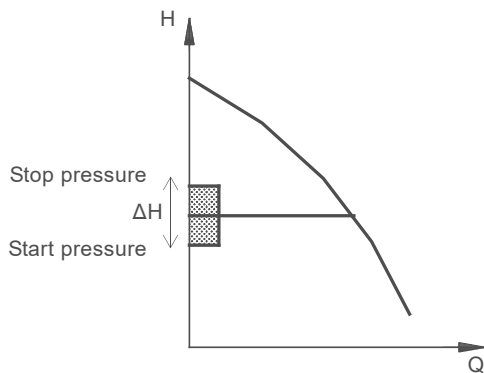

Fig. 28 Difference between start and stop pressures (ΔH)

ΔH is factory-set to **10 % of actual setpoint**.

ΔH can be set within the range from 5 % to 30 % of actual setpoint.

Low flow can be detected in two different ways:

1. A built-in "low-flow detection function" which functions if the digital input is not set up for flow switch.
2. A flow switch connected to the digital input.

1. Low-flow detection function

The pump will check the flow regularly by reducing the speed for a short time. If there is no or only a small change in pressure, this means that there is low flow. The speed will be increased until the stop pressure (actual setpoint + 0.5 x ΔH) is reached and the pump will stop. When the pressure has fallen to the start pressure (actual setpoint - 0.5 x ΔH), the pump will restart.

When restarting, the pumps will react differently according to pump type:

Three-phase pumps

1. If the flow is higher than the low-flow limit, the pump will return to continuous operation at constant pressure.
2. If the flow is still lower than the low-flow limit, the pump will continue in start/stop operation. It will continue in start/stop operation until the flow is higher than the low-flow limit; when the flow is higher than the low-flow limit, the pump will return to continuous operation.

2. Flow switch

When the digital input is activated for more than 5 seconds because there is low flow, the speed will be increased until the stop pressure (actual setpoint + 0.5 x ΔH) is reached, and the pump will stop. When the pressure has fallen to start pressure, the pump will start again. If there is still no flow, the pump will quickly reach stop pressure and stop. If there is flow, the pump will continue operating according to the setpoint.

Operating conditions for the stop function

It is only possible to use the stop function if the system incorporates a pressure sensor, a non-return valve and a diaphragm tank.

Caution

The non-return valve must always be installed before the pressure sensor. See fig. 29 and fig. 30.

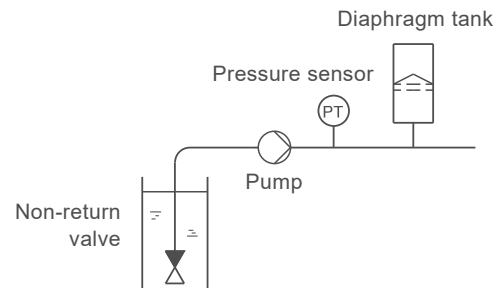

Fig. 29 Position of the non-return valve and pressure sensor in system with suction lift operation

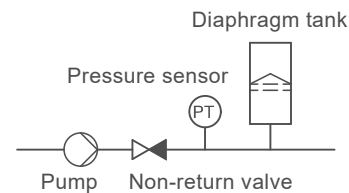

Fig. 30 Position of the non-return valve and pressure sensor in system with positive inlet pressure

Diaphragm tank

The stop function requires a diaphragm tank of a certain minimum size. The tank must be installed immediately after the pump and the precharge pressure must be 0.7 x actual setpoint.

Recommended diaphragm tank size:

Rated flow of pump [gpm (m ³ /h)]	CRE pump	Typical diaphragm tank size [gal (litre)]
0-26 (0 - 5.9)	1s, 1, 3	2 (7.6)
27-105 (6.1 - 23.8)	5, 10, 15	4.4 (16.7)
106-176 (24.2 - 40)	20, 32	14 (53.0)
177-308 (40.2 - 70.0)	45	34 (128.7)
309-440 (70.2 - 99.9)	64, 90	62 (234.7)
441-750 (100-170)	120, 150	86 (325.5)

If a diaphragm tank of the above size is installed in the system, the factory setting of ΔH is the correct setting.

If the tank installed is too small, the pump will start and stop too often. This can be remedied by increasing ΔH .

19.3.9 Flow limit for the stop function

Note

Flow limit for the stop function only works if the system is not set up for flow switch.



In order to set at which flow rate the system is to go from continuous operation at constant pressure to start/stop operation, select among these four values of which three are preconfigured flow limits:

- Low
- Normal
- High
- Custom.

The default setting of the pump is Normal, representing approx. 10 % of the rated flow rate of the pump.

If a lower flow limit than normal is desired or the tank size is smaller than recommended, select Low.

If a higher flow than normal is wanted or a large tank is used, set the limit to High.

The value Custom can be seen in R100 but it can only be set by means of the PC Tool E-products. Custom is for customized set-up and optimizing to the process.

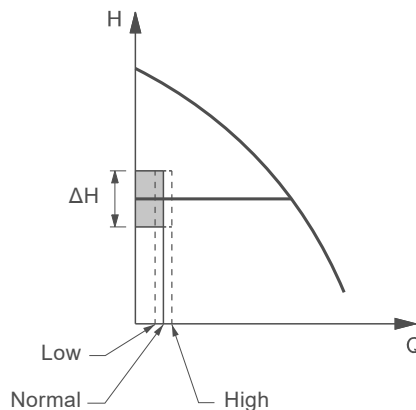

Fig. 31 Three preconfigured flow limits, Low, Normal and High

19.3.10 Sensor

Without sensor
(uncontrolled)



With pressure sensor
(controlled)



The setting of the sensor is only relevant in the case of controlled operation.

Select among the following values:

- Sensor output signal
 - 0-10 V
 - 0-20 mA
 - 4-20 mA,
- Unit of measurement of sensor:
 - bar, mbar, m, kPa, psi, ft, m³/h, m³/s, l/s, gpm, °C, °F, %,
- Sensor measuring range.

TM03 9060 3307

19.3.11 Duty/standby

The duty/standby function applies to two pumps connected in parallel and controlled via GENibus.



The duty/standby function can be set to these values:

- Active
- Not active.

When the function is set to Active, the following applies:

- Only one pump is running at a time.
- The stopped pump (standby) will automatically be cut in if the running pump (duty) has a fault. A fault will be indicated.
- Changeover between the duty pump and the standby pump will take place every 24 hours.

Activate the duty/standby function as follows:

1. Install and prime the two pumps according to the installation and operating instructions supplied with the pumps.
2. Check that the power supply is connected to the first pump according to the installation and operating instructions.
3. Use Grundfos R100 to set the duty/standby to Not active in the installation menu.
4. Use Grundfos R100 to set the Operating mode to Stop in the operation menu.
5. Use Grundfos R100 to set the other displays as required for the pump application (such as setpoint).
6. Disconnect the power supply to both pumps.
7. Installation of the AYB cable (91125604):
 - a. Remove the plug from each MLE terminal box with a flat head screw driver. See fig. 32.
 - b. Screw a new cable gland into each MLE terminal box with a crescent wrench. See fig. 32.
 - c. Loosen the new cable gland caps and push the cable ends through the cable glands and into MLE motors.
 - d. Remove the AYB connector plug from the first MLE motor. See fig. 33.
 - e. Connect the black wire to the A terminal of the AYB connector plug.
 - f. Connect the orange wire to the Y terminal of the AYB connector plug.
 - g. Connect the red wire to the B terminal of the AYB connector plug.
 - h. Reconnect the AYB connector plug to the first MLE motor.
 - i. Tighten the cable gland cap to secure the cable. See fig. 32.
 - j. Repeat steps d to i for the second MLE motor.
8. Connect the power supply to the two pumps according to the installation and operation instructions.
9. Use Grundfos R100 to check that the Operating mode is set to Normal in the operation menu of the second pump.
10. Use Grundfos R100 to set the other displays as required for the pump application (such as Setpoint).
11. Use Grundfos R100 to set the duty/standby to Active in the installation menu of the second pump. Please note the second pump will search for the first pump and automatically set the duty/standby to Active in the installation menu.
12. The second pump will operate for the first 24 hours. The two pumps will then alternate operation every 24 hours.

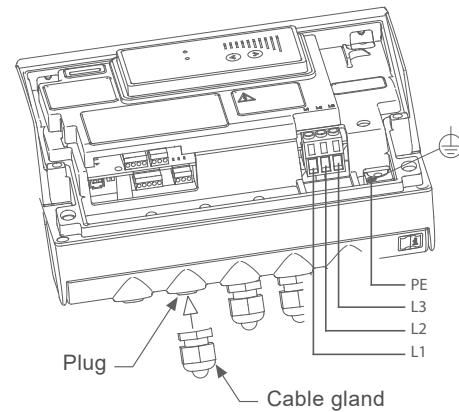

Fig. 32 Removing the plug and connecting cable gland to the terminal box

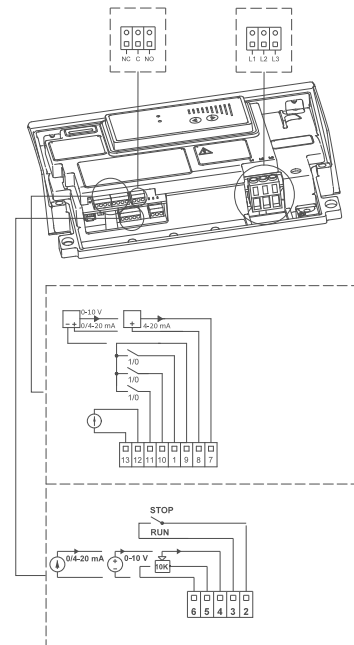
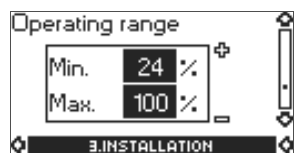

Fig. 33 AYB connector plug

TM05 1626 3311

TM05 2985 0812

19.3.12 Operating range



How to set the operating range:

- Set the min. curve within the range from max. curve to 12 % of maximum performance. The pump is factory-set to 24 % of maximum performance.
- Set the max. curve within the range from maximum performance (100 %) to min. curve.

The area between the min. and max. curves is the operating range.

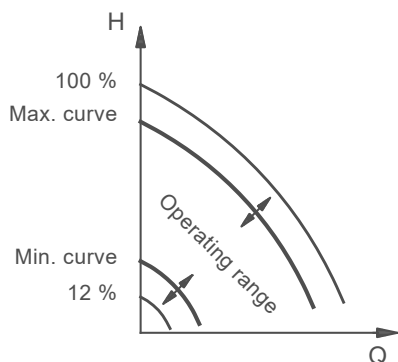

Fig. 34 Setting of the min. and max. curves in % of maximum performance

19.3.13 Motor bearing monitoring (only three-phase pumps)



The motor bearing monitoring function can be set to these values:

- Active
- Not active.

When the function is set to Active, a counter in the controller will start counting the mileage of the bearings. See section 19.2.7 *Lubrication status of motor bearings (only 15-30 hp)* on page 25.

The counter will continue counting even if the function is switched to Not active, but a warning will not be given when it is time for relubrication.

Note

When the function is switched to Active again, the accumulated mileage will again be used to calculate the relubrication time.

19.3.14 Confirming relubrication/replacement of motor bearings (only three-phase pumps)



This function can be set to these values:

- Relubricated (only 15-30 hp)
- Replaced
- Nothing done.

When the bearing monitoring function is Active, the controller will give a warning indication when the motor bearings are due to be relubricated or replaced. See section 19.1.3 *Fault indications* on page 23.

When the motor bearings have been relubricated or replaced, confirm this action in the above display by pressing OK.

Note

Relubricated cannot be selected for a period of time after confirming relubrication.

19.3.15 Standstill heating (only three-phase pumps)



The standstill heating function can be set to these values:

- Active
- Not active.

When the function is set to Active, an AC voltage will be applied to the motor windings. The applied voltage will ensure that sufficient heat is generated to avoid condensation in the motor.

TM00 7747 1896

19.4 Typical display settings for constant-pressure E-pumps

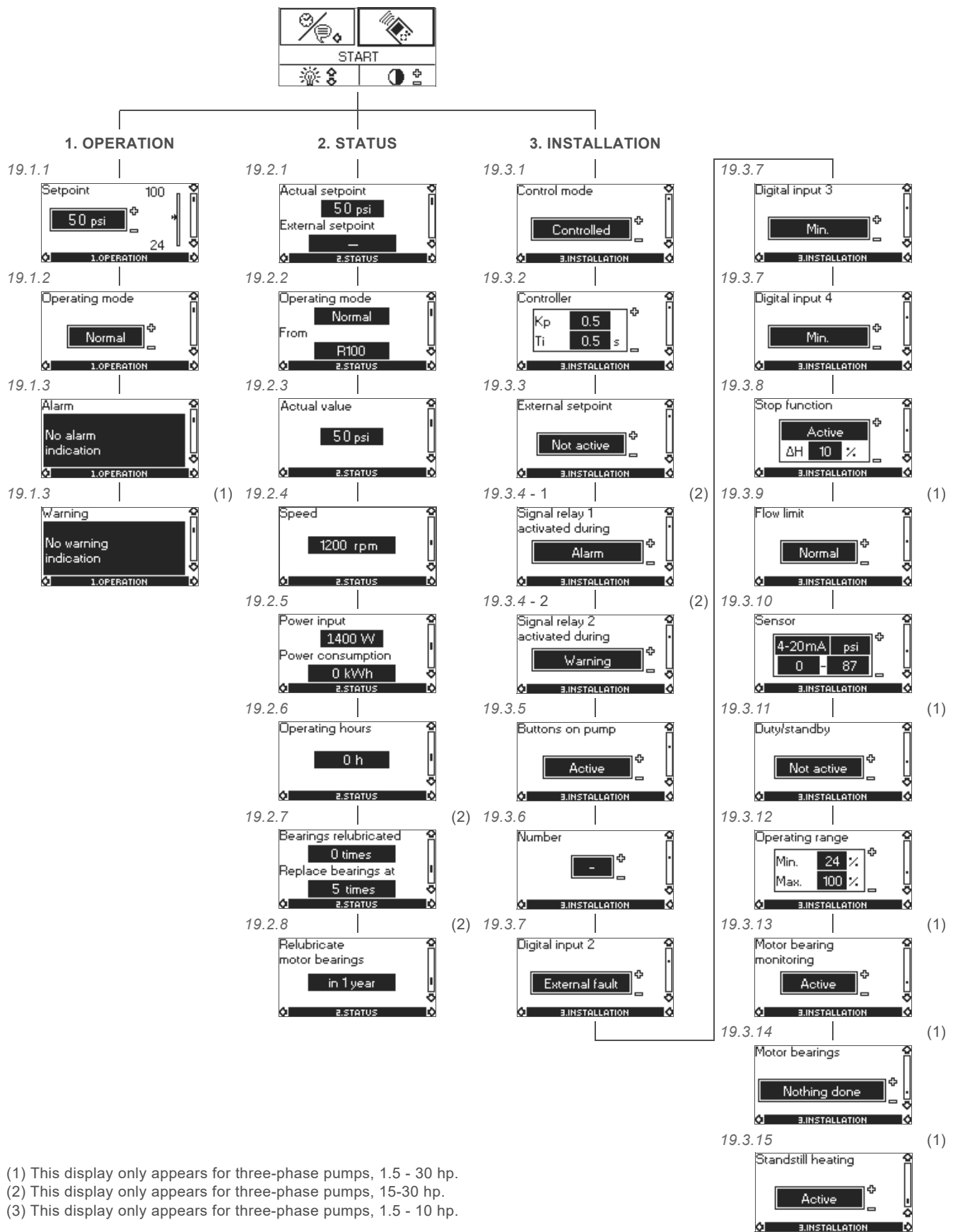

- (1) This display only appears for three-phase pumps, 1.5 - 30 hp.
- (2) This display only appears for three-phase pumps, 15-30 hp.
- (3) This display only appears for three-phase pumps, 1.5 - 10 hp.

Fig. 35 Menu overview

19.5 Typical display settings for analog-input E-pumps

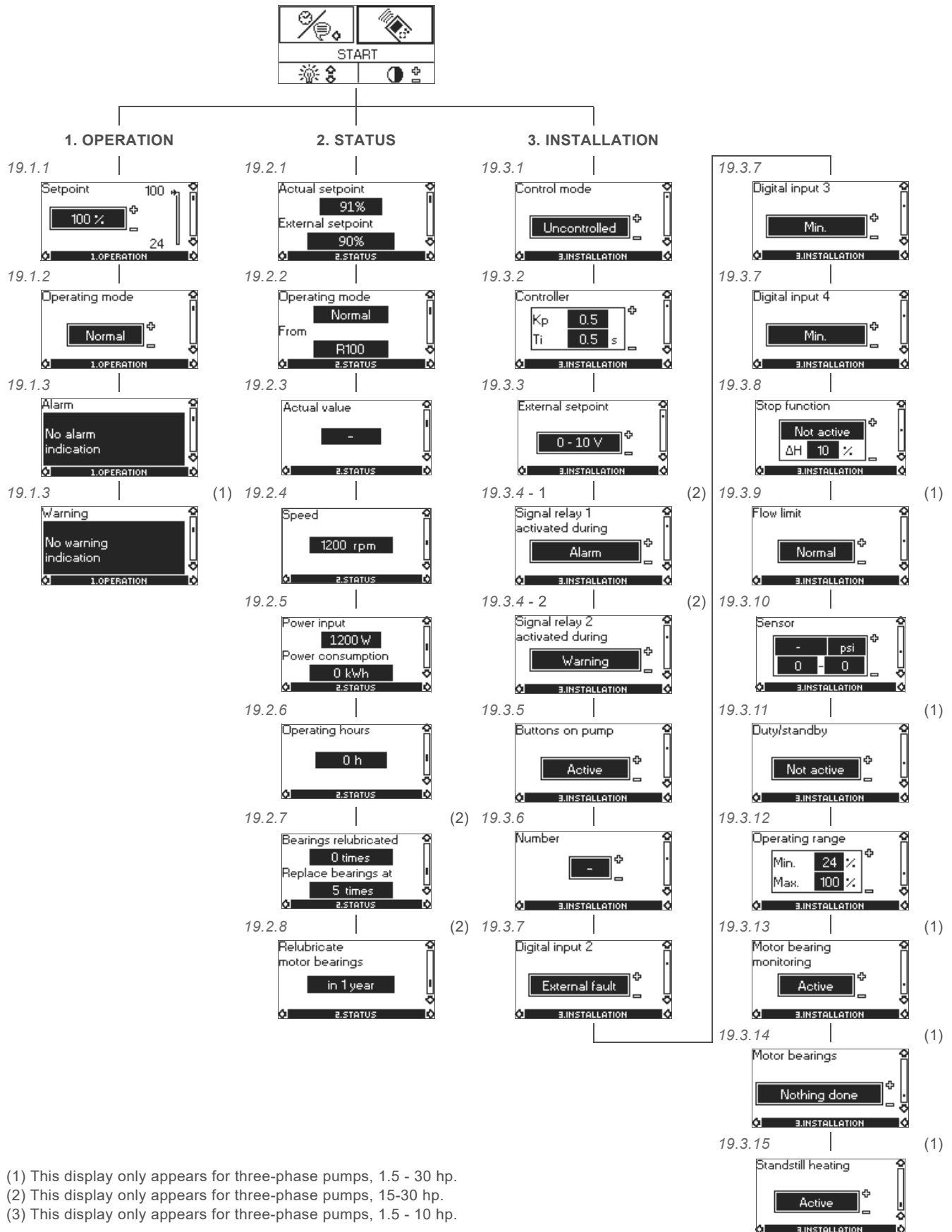

- (1) This display only appears for three-phase pumps, 1.5 - 30 hp.
- (2) This display only appears for three-phase pumps, 15-30 hp.
- (3) This display only appears for three-phase pumps, 1.5 - 10 hp.

Fig. 36 Menu overview

19.6 Grundfos GO Remote

The motor is designed for wireless radio or infrared communication with Grundfos GO Remote.

Grundfos GO Remote enables setting of functions and gives access to status overviews, technical product information and actual operating parameters.

Grundfos GO Remote offers three different mobile interfaces (MI). See fig. 37.

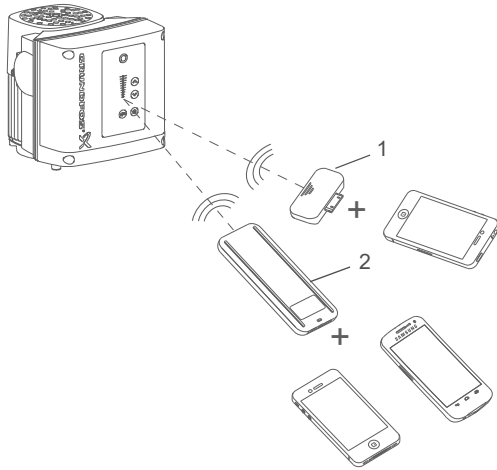

Fig. 37 Grundfos GO Remote communicating with the motor via radio or infrared light

Pos.	Description
1	Grundfos MI 202: Add-on module which can be used in conjunction with Apple iPod touch 4, iPhone 4G or later.
	Grundfos MI 204: Add-on module which can be used in conjunction with Apple iPod touch 5G or iPhone 5.
2	Grundfos MI 301: Separate module enabling radio or infrared communication. The module can be used in conjunction with an Android or iOS-based Smartphone with Bluetooth connection.

19.6.1 Communication

When Grundfos GO Remote communicates with the pump, the indicator light in the middle of the Grundfos Eye will flash green.

Communication must be established using one of these communication types:

- radio communication
- infrared communication.

Radio communication

Radio communication can take place at distances up to 30 meters. It is necessary to enable communication by pressing or on the pump control panel.

Infrared communication

When communicating via infrared light, Grundfos GO Remote must be pointed at the pump control panel.

19.6.2 Navigation

Navigation can be done from the dashboard. See fig. 38.

Dashboard

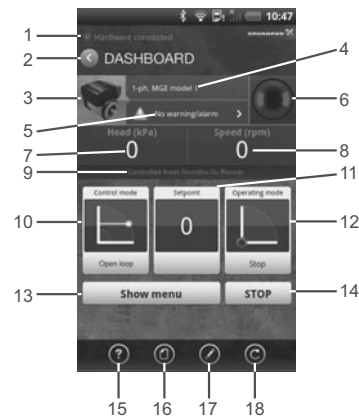

Fig. 38 Example of dashboard

Pos.	Description	Action
1	Connection indicator	This text appears when Grundfos GO Remote app has connected to an MI 204, MI 202 or MI 301. If the hardware is not connected, it will not be possible to communicate with a Grundfos product.
2	Back button	Returns to the previous display.
3	Product information	Provides technical information about the product.
4	Product name	Name of the product communicating with Grundfos GO Remote.
5	Alarms and warnings	Shows alarms and warnings.
6	Grundfos Eye	Shows the operating condition of the product.
7	Primary status value	Shows the primary status value.
8	Secondary status value	Shows the secondary status value.
9	Control source	Shows by which interface the product is controlled.
10	Control mode	Shows the control mode of the product.
11	Actual setpoint value	Shows the actual setpoint value.
12	Operating mode	Shows the operating mode.
13	Show menu	Gives access to other menus.
14	Stop	Stops the product.
Tool bar		
15	Help	The help function describes the menu making it easy for the user to change settings, etc.
16	Documentation	Gives access to installation and operating instructions and quick guides.
17	Report	Enables the creation of user-defined reports.
18	Update	Enables update of Grundfos GO Remote app.

TM06 0733 0814

TM05 5609 3912

20. Setting by means of PC Tool E-products

Special setup requirements differing from the settings available via the R100 require the use of Grundfos PC Tool E-products. This again requires the assistance of a Grundfos service technician or engineer. Contact your local Grundfos company for more information.

21. Priority of settings

The priority of settings depends on two factors:

1. control source
2. settings.

1. Control source

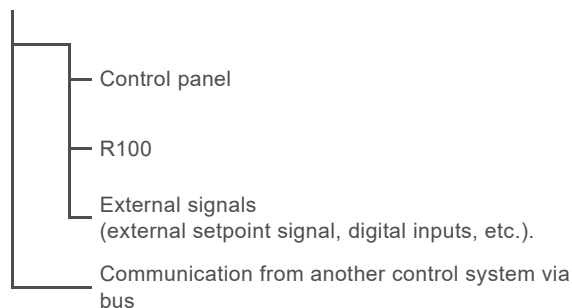

2. Settings

- Operating mode Stop
- Operating mode Max. (Max. curve)
- Operating mode Min. (Min. curve)
- Setpoint setting.

An E-pump can be controlled by different control sources at the same time, and each of these sources can be set differently. Consequently, it is necessary to set an order of priority of the control sources and the settings.

Note

If two or more settings are activated at the same time, the pump will operate according to the function with the highest priority.

Priority of settings without bus communication

Priority	Control panel or R100	External signals
1	Stop	
2	Max.	
3		Stop
4		Max.
5	Min.	Min.
6	Setpoint setting	Setpoint setting

Example: If the E-pump has been set to operating mode Max. (Max. frequency) via an external signal, such as digital input, the control panel or R100 can only set the E-pump to operating mode Stop.

Priority of settings with bus communication

Priority	Control panel or R100	External signals	Bus communication
1	Stop		
2	Max.		
3		Stop	Stop
4			Max.
5			Min.
6			Setpoint setting

Example: If the E-pump is operating according to a setpoint set via bus communication, the control panel or R100 can set the E-pump to operating mode Stop or Max., and the external signal can only set the E-pump to operating mode Stop.

22. External forced-control signals

The pump has inputs for external signals for these forced-control functions:

- Start/stop of pump
- Digital function.

22.1 Start/stop input

Functional diagram: Start/stop input:

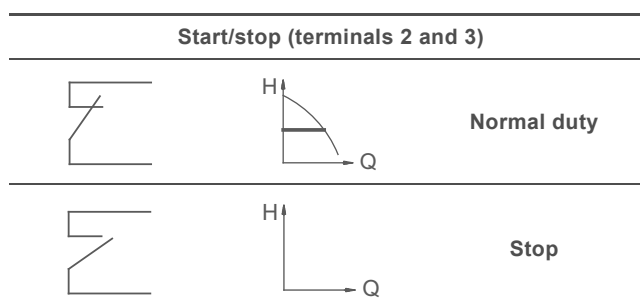

22.2 Digital input

By means of the , one of the following functions can be selected for the digital input:

- Normal duty
- Min. curve
- Max. curve
- External fault
- Flow switch
- Dry running.

Functional diagram: Input for digital function

Digital function		
(terminals 1 and 9)	(terminals 9 and 10)	(terminals 9 and 11)
Normal duty		
Min. curve		
Max. curve		
External fault		
Flow switch		
Dry running		

23. External setpoint signal

The setpoint can be remote-set by connecting an analogue signal transmitter to the input for the setpoint signal (terminal 4).

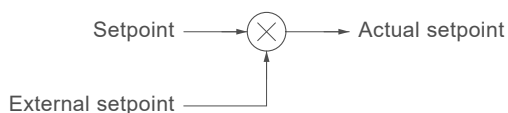

Fig. 39 Actual setpoint as a product (multiplied value) of setpoint and external setpoint

Select the actual external signal, 0-10 V, 0-20 mA, 4-20 mA, via the R100. See section 19.3.3 *External setpoint* on page 26.

If control mode **uncontrolled** is selected by means of the R100, the pump can be controlled by any controller.

In control mode **controlled**, the setpoint can be set externally within the range from the lower value of the sensor measuring range to the setpoint set on the pump or by means of the R100.

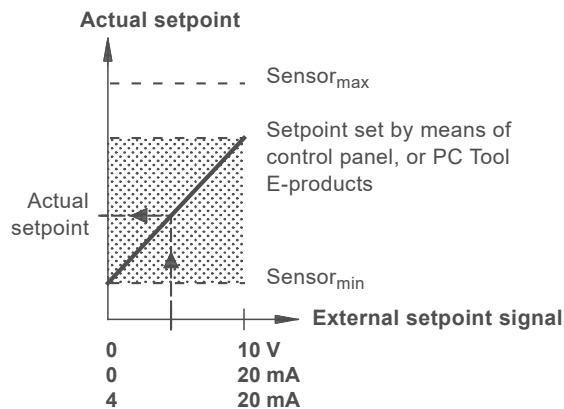

Fig. 40 Relation between the actual setpoint and the external setpoint signal in control mode controlled

Example: At a sensor_{min} value of 0 psi, a setpoint set of 50 psi and an external setpoint of 80 % (an 8 V analog signal to Terminal 4 if using an analog signal of 0-10 V), the actual setpoint will be as follows:

$$\begin{aligned} \text{Actual setpoint} &= (\text{setpoint} - \text{sensor}_{\min}) \times \%_{\text{external setpoint}} + \text{sensor}_{\min} \\ &= (50 - 0) \times 80 \% + 0 \\ &= 40 \text{ psi} \end{aligned}$$

In control mode **uncontrolled**, the setpoint can be set externally within the range from the min. curve to the setpoint set on the pump or by means of the R100. Typically the setpoint is set to 100 % when the control mode is uncontrolled (see section 19.5 *Typical display settings for analog-input E-pumps* on page 33).

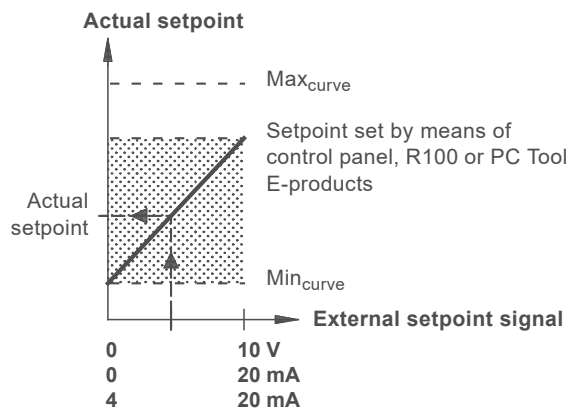

Fig. 41 Relation between the actual setpoint and the external setpoint signal in control mode uncontrolled

24. Bus signal

The pump supports serial communication via an RS-485 input. The communication is carried out according to Grundfos bus protocol, GENibus protocol, and enables connection to a building management system or another external control system.

Operating parameters, such as setpoint, operating mode, etc. can be remote-set via the bus signal. At the same time, the pump can provide status information about important parameters, such as actual value of control parameter, input power, fault indications, etc.

Contact Grundfos for further details.

Note

If a bus signal is used, the number of settings available via the R100 will be reduced.

25. Other bus standards

Grundfos offers various bus solutions with communication according to other standards.

Contact Grundfos for further details.

26. Indicator lights and signal relay

The operating condition of the pump is indicated by the green and red indicator lights fitted on the pump control panel and inside the terminal box. See fig. 42.

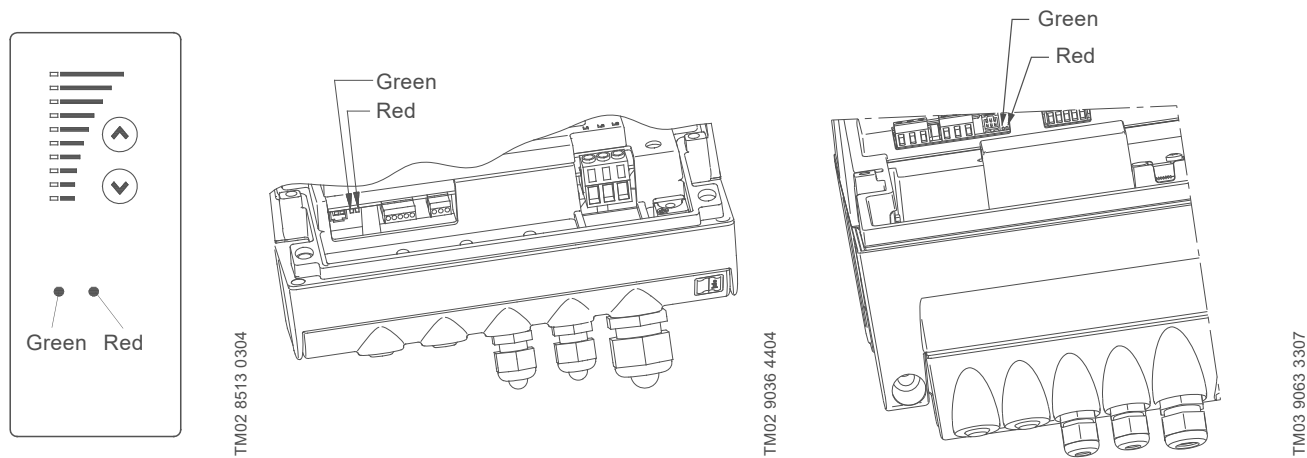





























Fig. 42 Position of indicator lights

Besides, the pump incorporates an output for a potential-free signal via an internal relay.





For signal relay output values, see section 19.3.4 *Signal relay* on page 27.

The functions of the two indicator lights and the signal relay are as shown in the following table:

Indicator lights		Signal relay activated during:				Description
Fault (red)	Operation (green)	Fault/Alarm, Warning and Relubricate	Operating	Ready	Pump running	
Off	Off					The power supply has been switched off.
Off	Permanently on					The pump is operating.
Off	Permanently on					The pump is stopped by the stop function.
Off	Flashing					The pump has been set to stop.
Permanently on	Off					The pump has stopped because of a Fault/Alarm or is running with a Warning or Relubricate indication. If the pump was stopped, restarting will be attempted (it may be necessary to restart the pump by resetting the Fault indication). If the cause is "external fault", the pump must be restarted manually by resetting the Fault indication.
Permanently on	Permanently on					The pump is operating, but it has or has had a Fault/Alarm allowing the pump to continue operation or it is operating with a Warning or Relubricate indication. If the cause is "sensor signal outside signal range", the pump will continue operating according to the 70 % curve and the fault indication cannot be reset until the signal is inside the signal range. If the cause is "setpoint signal outside signal range", the pump will continue operating according to the min. curve and the fault indication cannot be reset until the signal is inside the signal range.
Permanently on	Flashing					The pump has been set to stop, but it has been stopped because of a Fault.

Resetting of fault indication

A fault indication can be reset in one of the following ways:

- Briefly press the button  or  on the pump. This will not change the setting of the pump.
A fault indication cannot be reset by means of  or  if the buttons have been locked.
- Switch off the power supply until the indicator lights are off.
- Switch the external start/stop input off and then on again.
- Use the R100. See section 19.1.3 *Fault indications*.

When the R100 communicates with the pump, the red indicator light will flash rapidly.

27. Emergency operation (only 15-30 hp)



Warning

Never make any connections in the pump terminal box unless all electric supply circuits have been switched off for at least 5 minutes.
Note for instance that the signal relay may be connected to an external supply which is still connected when the power supply is disconnected.

If the pump is stopped and you cannot start the pump immediately after normal remedies, the reason could be a faulty frequency converter. If this is the case it is possible to maintain emergency operation of the pump.

Before change over to emergency operation we recommend you to:

- check that the power supply is OK
- check that control signals are working (start/stop signals)
- check that all alarms are reset
- make a resistance test on the motor windings (disconnect the motor leads from the terminal box).

If the pump remains stopped it is possible that the frequency converter is faulty.

To establish emergency operation proceed as follows:

1. Disconnect the three power supply leads, L1, L2, L3, from the terminal box, but leave the protective ground lead(s) in position on the PE terminal(s).

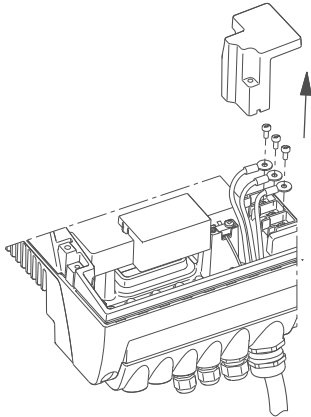

TM03 8607 2007

2. Disconnect the motor supply leads, U/W1, V/U1, W/V1, from the terminal box.

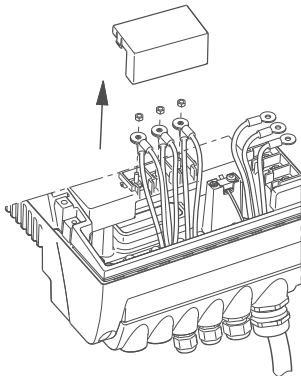

TM03 9120 3407

3. Connect the leads as shown in fig. 43.

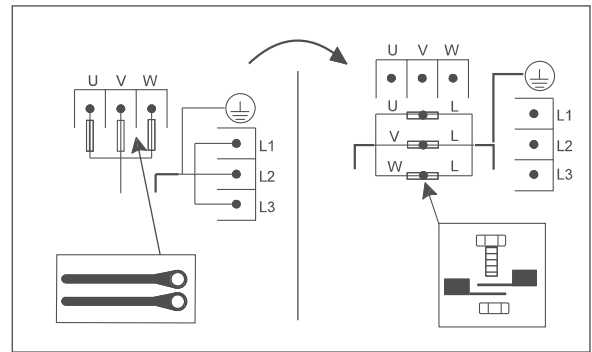

TM04 0018 4807

Fig. 43 How to switch an E-pump from normal operation to emergency operation

Use the screws from the power supply terminals and the nuts from the motor terminals.

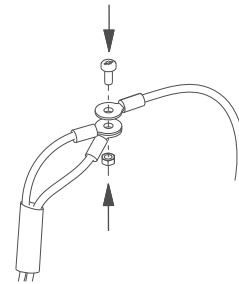

TM03 9121 3407

4. Insulate the three leads from each other by means of insulating tape or the like.

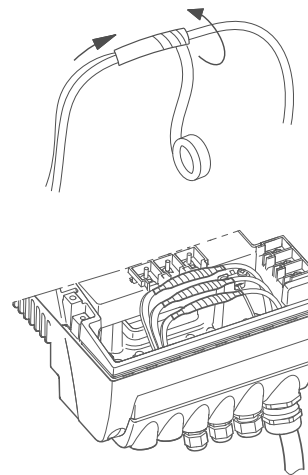

TM03 9122 3407

TM03 9123 3407

Warning

Do not bypass the frequency converter by connecting the power supply leads to the U, V and W terminals.

This may cause hazardous situations for personnel as the high voltage potential of the power supply may be transferred to touchable components in the terminal box.



Caution

Check the direction of rotation when starting up after switching to emergency operation.

5. A motor starter is required.

28. Insulation resistance

3-10 hp

Caution

Do not measure the insulation resistance of motor windings or an installation incorporating E-pumps using high voltage megging equipment, as this may damage the built-in electronics.

15-30 hp

Caution

Do not measure the insulation resistance of an installation incorporating E-pumps using high voltage megging equipment, as this may damage the built-in electronics.

The motor leads can be disconnected separately and the insulation resistance of the motor windings can be tested.

29. Maintenance and service

29.1 Cleaning of the motor

Keep the motor cooling fins and fan blades clean to ensure sufficient cooling of the motor and electronics.

29.2 Relubrication of motor bearings

3-10 hp pumps

The motor bearings are of the closed type and greased for life. The bearings cannot be relubricated.

15-30 hp pumps

The motor bearings are of the open type and must be relubricated regularly. The motor bearings are prelubricated on delivery. The built-in bearing monitoring function will give a warning indication on the R100 when the motor bearings are due to be relubricated.

Note

Before relubrication, remove the bottom plug in the motor flange and the plug in the bearing cover to ensure that old and excess grease can escape.

When relubricating the first time, use the double quantity of grease as the lubricating channel is still empty.

Frame size	Quantity of grease [ounces]	
	Drive end (DE)	Non-drive end (NDE)
MLE 160	.44	.44
MLE 180	.51	.51

The recommended grease type is a polycarbamide-based lubricating grease.

29.3 Replacement of motor bearings

15-30 hp motors have built-in bearing monitoring function which will give a warning indication on the Grundfos Go or R100 when the motor bearings are due to be replaced.

29.4 Replacement of varistor (only 15-30 hp)

The varistor protects the pump against voltage transients. If voltage transients occur, the varistor will be worn over time and need to be replaced. The more transients, the more quickly the varistor will be worn. When it is time to replace the varistor, Grundfos GO, R100 and PC Tool E-products will indicate this as a warning.

A Grundfos technician is required for replacement of the varistor. Contact your local Grundfos company for assistance.

29.5 Service parts and service kits

For further information on service parts and service kits, visit www.grundfos.com, select country, select WebCAPS.

30. Technical data - three-phase pumps, 3-10 hp

30.1 Supply voltage

3 x 440-480 V - 10 %/+ 10 %, 60 Hz - 2 %/+ 2 %, PE.

3 x 208-230 V - 10 %/+ 10 %, 60 Hz - 2 %/+ 2 %, PE.

Cable: Max 10 mm² / 8 AWG.

Use min. 158 °F (70 °C) copper conductors only.

Recommended fuse sizes

Motor sizes from 3 - 7.5 hp: Max. 16 A.

Motor size 10 hp: Max. 32 A.

Standard as well as quick-blow or slow-blow fuses may be used.

30.2 Overload protection

The overload protection of the E-motor has the same characteristic as an ordinary motor protector. As an example, the E-motor can stand an overload of 110 % of I_{nom} for 1 min.

30.3 Leakage current

Motor size [hp]	Leakage current [mA]
3 hp (supply voltage < 460 V)	< 3.5
3 hp (supply voltage > 460 V)	< 5
5 to 7.5 hp	< 5
10 hp	< 10

The leakage currents are measured in accordance with EN 61800-5-1.

30.4 Inputs/output

Start/stop

External potential-free contact.

Voltage: 5 VDC.

Current: < 5 mA.

Screened cable: 20-16 AWG (0.5 - 1.5 mm²).

Digital

External potential-free contact.

Voltage: 5 VDC.

Current: < 5 mA.

Screened cable: 20-16 AWG (0.5 - 1.5 mm²).

Setpoint signals

- Potentiometer
0-10 VDC, 10 k Ω (via internal voltage supply).
Screened cable: 20-16 AWG (0.5 - 1.5 mm²).
Maximum cable length: 328 ft (100 m).
- Voltage signal
0-10 VDC, $R_i > 50$ k Ω .
Tolerance: + 0 %/- 3 % at maximum voltage signal.
Screened cable: 20-16 AWG (0.5 - 1.5 mm²).
Maximum cable length: 1640 ft (500 m).
- Current signal
DC 0-20 mA / 4-20 mA, $R_i = 175$ Ω .
Tolerance: + 0 %/- 3 % at maximum current signal.
Screened cable: 20-16 AWG (0.5 - 1.5 mm²).
Maximum cable length: 1640 ft (500 m).

Sensor signals

- Voltage signal
0-10 VDC, $R_i > 50$ k Ω (via internal voltage supply).
Tolerance: + 0 %/- 3 % at maximum voltage signal.
Screened cable: 20-16 AWG (0.5 - 1.5 mm²).
Maximum cable length: 1640 ft (500 m).
- Current signal
DC 0-20 mA / 4-20 mA, $R_i = 175$ Ω .
Tolerance: + 0 %/- 3 % at maximum current signal.
Screened cable: 20-16 AWG (0.5 - 1.5 mm²).
Maximum cable length: 1640 ft (500 m).

Internal power supplies

- 10 V power supply for external potentiometer:
Max. load: 2.5 mA.
Short-circuit protected.
- 24 V power supply for sensors:
Max. load: 40 mA.
Short-circuit protected.

Signal relay output

Potential-free changeover contact.

Maximum contact load: 250 VAC, 2 A, $\cos \varphi$ 0.3 - 1.

Minimum contact load: 5 VDC, 10 mA.

Screened cable: 0.5 - 2.5 mm² / 28-12 AWG.

Maximum cable length: 1640 ft (500 m).

Bus input

Grundfos bus protocol, GENIbus protocol, RS-485.

Screened 3-core cable: 28-16 AWG (0.2 - 1.5 mm²).

Maximum cable length: 1640 ft (500 m).

31. Technical data - three-phase pumps, 15-30 hp

31.1 Supply voltage

3 x 440-480 V - 10 %/+ 10 %, 60 Hz - 3 %/+ 3 %, PE.

Cable: Max. 8 AWG (10 mm²)

Use min. 158 °F (70 °C) copper conductors only.

Recommended fuse sizes

Motor size [hp]	Max. [A]
15	32
20	36
25	43
30	51

Standard as well as quick-blow or slow-blow fuses may be used.

31.2 Overload protection

The overload protection of the E-motor has the same characteristic as an ordinary motor protector. As an example, the E-motor can stand an overload of 110 % of I_{nom} for 1 min.

31.3 Leakage current

Ground leakage current > 10 mA.

The leakage currents are measured in accordance with EN 61800-5-1.

31.4 Inputs/output

Start/stop

External potential-free contact.

Voltage: 5 VDC.

Current: < 5 mA.

Screened cable: 20-16 AWG (0.5 - 1.5 mm²).

Digital

External potential-free contact.

Voltage: 5 VDC.

Current: < 5 mA.

Screened cable: 20-16 AWG (0.5 - 1.5 mm²).

Setpoint signals

- Potentiometer
0-10 VDC, 10 k Ω (via internal voltage supply).
Screened cable: 20-16 AWG (0.5 - 1.5 mm²).
Maximum cable length: 328 ft (100 m).
- Voltage signal
0-10 VDC, $R_i > 50$ k Ω .
Tolerance: + 0 %/- 3 % at maximum voltage signal.
Screened cable: 20-16 AWG (0.5 - 1.5 mm²).
Maximum cable length: 1640 ft (500 m).
- Current signal
DC 0-20 mA / 4-20 mA, $R_i = 250$ Ω .
Tolerance: + 0 %/- 3 % at maximum current signal.
Screened cable: 20-16 AWG (0.5 - 1.5 mm²).
Maximum cable length: 1640 ft (500 m).

Sensor signals

- Voltage signal
0-10 VDC, $R_i > 50 \text{ k}\Omega$ (via internal voltage supply).
Tolerance: + 0 %/- 3 % at maximum voltage signal.
Screened cable: 20-16 AWG (0.5 - 1.5 mm²).
Maximum cable length: 1640 ft (500 m).
- Current signal
DC 0-20 mA / 4-20 mA, $R_i = 250 \Omega$.
Tolerance: + 0 %/- 3 % at maximum current signal.
Screened cable: 20-16 AWG (0.5 - 1.5 mm²).
Maximum cable length: 1640 ft (500 m).

Internal power supplies

- 10 V power supply for external potentiometer:
Max. load: 2.5 mA.
Short-circuit protected.
- 24 V power supply for sensors:
Max. load: 40 mA.
Short-circuit protected.

Signal relay output

Potential-free changeover contact.
Maximum contact load: 250 VAC, 2 A, $\cos \varphi 0.3 - 1$.
Minimum contact load: 5 VDC, 10 mA.
Screened cable: 0.5 - 2.5 mm² / 28-12 AWG.
Maximum cable length: 1640 ft (500 m).

Bus input

Grundfos bus protocol, GENIbus protocol, RS-485.
Screened 3-core cable: 28-16 AWG (0.2 - 1.5 mm²).
Maximum cable length: 1640 ft (500 m).

31.5 Other technical data

EMC (electromagnetic compatibility to EN 61800-3)

Motor [hp]	Emission/immunity
3	Emission:
5	The motors may be installed in residential areas (first environment), unrestricted distribution, corresponding to CISPR11, group 1, class B.
7.5	
10	
10	Immunity: The motors fulfil the requirements for both the first and second environment.
15	Emission: The motors are category C3, corresponding to CISPR11, group 2, class A, and may be installed in industrial areas (second environment). If equipped with an external Grundfos EMC filter, the motors are category C2, corresponding to CISPR11, group 1, class A, and may be installed in residential areas (first environment).
20	
25	
25	
30	



Warning

When the motors are installed in residential areas, supplementary measures may be required as the motors may cause radio interference.

Motor sizes 15, 25, and 30 hp comply with EN 61000-3-12 provided that the short-circuit power at the interface point between the user's electrical installation and the public power supply network is greater than or equal to the values stated below. It is the responsibility of the installer or user to ensure, by consultation with the power supply network operator, if necessary, that the motor is connected to a power supply with a short-circuit power greater than or equal to these values:

Motor size [hp]	Short-circuit power [kVA]
15	1500
20	-
25	2700
30	3000

Note 20 hp motors do not comply with EN 61000-3-12.

By installing an appropriate harmonic filter between the motor and the power supply, the harmonic current content will be reduced. In this way, the 20 hp motor will comply with EN 61000-3-12.

Immunity:

The motors fulfill the requirements for both the first and second environment.

Contact Grundfos for further information.

Enclosure class

- Three-phase pumps, 3-10 hp: IP55 (IEC 34-5)
- Three-phase pumps, 15-30 hp: IP55 (IEC 34-5)

Insulation class

F (IEC 85)

Ambient temperature

During operation:

- Min -4 °F (-20 °C)
- Max +104 °F (40 °C) without derating

During storage/transport:

- -40 °F (-40 °C) to +140 °F (+60 °C) (3-10 hp)
- -13 °F (-25 °C) to +158 °F (70 °C) (15-30 hp)

Relative air humidity

Maximum 95 %.

Sound pressure level

Motor [hp]	Sound pressure level [dB(A)]	
	2-POLE	4-POLE
3	82	64
5	87	75
7.5	93	69
10	82	71
15	68	64
20	68	66
25	70	72
30	70	

32. Installation in the USA and Canada**Note**

In order to maintain the UL/cUL approval, follow these additional installation instructions. The UL approval is according to UL508C.

32.1 Electrical connection**32.1.1 Conductors**

Use minimum 140/167 °F (60/75 °C) copper conductors only.

32.1.2 Torques**Power terminals**

Power terminal: 1.7 ft-lbs (2.3 Nm)

Relay, M2.5: 0.4 ft-lbs (0.5 Nm)

Input control, M2: 0.15 ft-lbs (0.2 Nm)

32.1.3 Line reactors

Max. line reactor size must not exceed 2 mH.

32.1.4 Fuse size/circuit breaker

If a short circuit happens the pump can be used on a power supply delivering not more than 5000 RMS symmetrical amperes, 480 V maximum.

Fuses

When the pump is protected by fuses they must be rated for 600 V. Maximum sizes are stated in table below.

Up to 10 hp use Class K5 UL Listed fuses. For 10 to 30 hp use any class UL Listed fuse.

Circuit breaker

When the pump is protected by a circuit breaker, this must be rated for a maximum voltage of 480 V. The circuit breaker must be of the "Inverse time" type.

The interrupting rating (RMS symmetrical amperes) must not be less than the values stated in table below.

USA - hp

2-pole	4-pole	Fuse size	Circuit breaker type/model
3	3	25 A	25 A / Inverse time
5	5	40 A	40 A / Inverse time
7.5	-	40 A	40 A / Inverse time
10	7.5	50 A	50 A / Inverse time
15	15	80 A	80 A / Inverse time
20	20	110 A	110 A / Inverse time
25	25	125 A	125 A / Inverse time
30	-	150 A	150 A / Inverse time

32.1.5 Overload protection

Degree of overload protection provided internally by the drive, in percent of full-load current: 102 %.

32.2 General considerations

For installation in humid environment and fluctuating temperatures, it is recommended to keep the pump connected to the power supply continuously. This will prevent moisture and condensation build-up in the terminal box.

Start and stop must be done via the start/stop digital input (terminal 2-3).

33. Disposal

This product or parts of it must be disposed of in an environmentally sound way:

1. Use the public or private waste collection service.
2. If this is not possible, contact the nearest Grundfos company or service workshop.

Subject to alterations.

Grundfos CBS Inc.
902 Koomey Road
Brookshire, TX 77423 USA
Phone: 281-994-2700
Toll Free: 1-800-955-5847
Fax: 1-800-945-4777

www.grundfosexpresssuite.com

98670143 0714
ECM: 1139229

© Copyright Grundfos Holding A/S

The name Grundfos, the Grundfos logo, and be think innovate are registered trademarks owned by Grundfos Holding A/S or Grundfos A/S, Denmark. All rights reserved worldwide.