

# IT'S TIME TO DEMAND MORE

**Simple to install,  
Simple to operate.  
Simply the best.**

The Grundfos ALPHA will change the way you view circulators. With its uniquely patented AUTOADAPT™ feature - this energy efficient circulator controls pump performance automatically within a defined performance range, thus saving up to 85% of energy consumption.

For installation, you also have the flexibility to use either our unique ALPHA Plug with line cord or the ALPHA with terminal box for conduit connection applications. The choice is yours.



be  
think  
innovate

**GRUNDFOS** 

# THE UNIQUE FEATURES OF THE GRUNDFOS ALPHA™



Unique ALPHA Plug with line cord



Terminal box for conduit connection applications



Large display shows current energy consumption in Watts



Large display shows estimated flow in gallons per minute



A one button, easy-to-use interface



Nut capture



Compact design



Stainless steel and cast iron pump housing available



Integrated check-valve (optional)

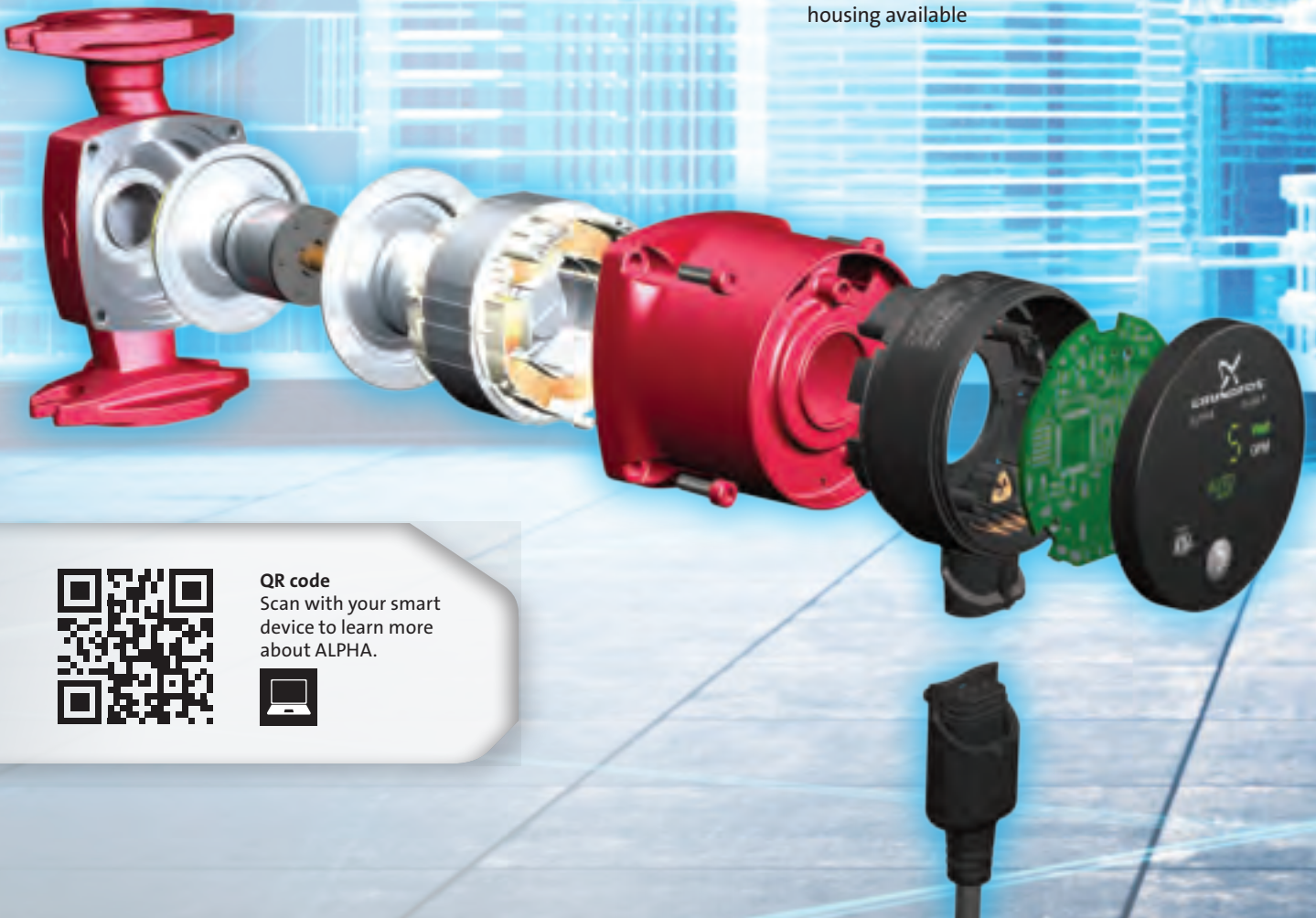

QR code  
Scan with your smart device to learn more about ALPHA.





## Technical Data:

<b>Flow Range:</b>	0 to 21 GPM
<b>Head Range:</b>	0 to 19 Feet
<b>Motor:</b>	1X115V
<b>Min. Fluid Temperature:</b>	36°F (2°C)
<b>Max. Fluid Temperature:</b>	230°F (110°C)
<b>Max. Working Pressure:</b>	150 PSI
<b>Watts:</b>	5-45W
<b>Amps:</b>	0.65A





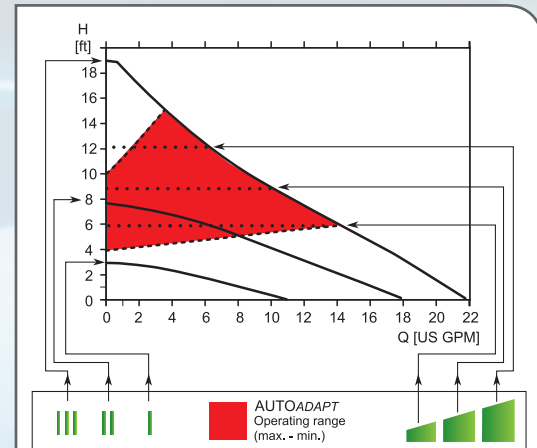

## Product Offering:

Model	Description	Part #
ALPHA 15-55F	Cast iron flange with terminal box	59896877
ALPHA 15-55FR	Cast iron rotated flange with terminal box	59896878
ALPHA 15-55SF	Stainless flange with terminal box	59896879
ALPHA 15-55F/LC	Cast iron flange with line cord	59896832
ALPHA 15-55FR/LC	Cast iron rotated flange with line cord	59896833
ALPHA 15-55SF/LC	Stainless flange with line cord	59896834
	Service Kit - Line cord	91130247
	Service Kit - Terminal box	91130312

## Performance Curve:



### ALPHA APPROXIMATE POWER USAGE

Speed setting	Min.	Max.
High fixed speed 	39W	45W
Medium fixed speed 	15W	30W
Low fixed speed 	5W	8W
Constant pressure 	8W	45W
Constant pressure 	14W	45W
Constant pressure 	22W	45W
AutoADAPT 	5W	45W

## Dimensional Drawing:

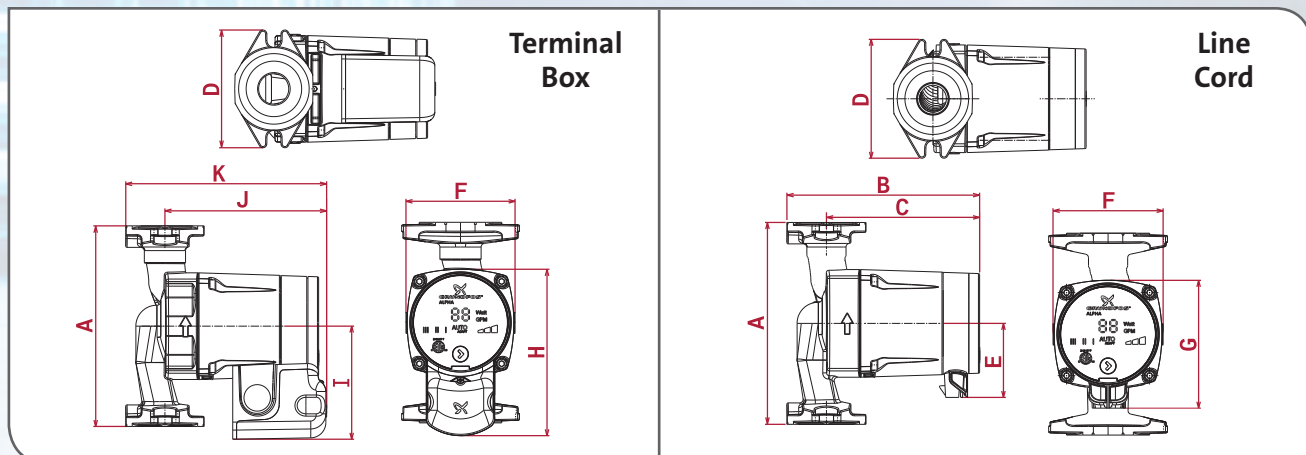

A	B	C	D	E	F	G	H	I	J	K
6-1/2	6-3/16	4-15/16	3-13/16	2-3/8	3-7/16	4-1/8	5-3/8	6-11/16	5-1/4	6-1/2

At Grundfos, we believe in making the complicated seem simple and innovative technology intuitive. Bringing more flexibility and ease of use to your workflow, *AUTOADAPT* technology is revolutionary to the market. As the ideal choice for more than 80% of systems, *AUTOADAPT* will continuously search for the lowest possible head to meet system requirements and find the setting that provides optimal comfort with minimal energy consumption.

You can also go online and explore our Modern Comfort site for all your domestic buildings needs. Visit:

**[moderncomfort.grundfos.us](http://moderncomfort.grundfos.us)**



L-AL-SL-001 Rev. 02-14

**GRUNDFOS Kansas City**  
17100 West 118th Terrace  
Olathe, Kansas 66061  
Phone: (913) 227-3400  
Fax: (913) 227-3500

[www.grundfos.us](http://www.grundfos.us)

**GRUNDFOS Canada**  
2941 Brighton Road  
Oakville, Ontario  
L6H 6C9  
Phone: (905) 829-9533  
Fax: (905) 829-9512

[www.grundfos.ca](http://www.grundfos.ca)

**GRUNDFOS Mexico**  
Boulevard TLC No. 15  
Parque Industrial Stiva Aeropuerto  
C.P. 66600 Apodaca, N.L. Mexico  
Phone: 011-52-81-8144 4000  
Fax: 011-52-81-8144 4010

[www.grundfos.mx](http://www.grundfos.mx)

